

Document title

REQUEST FOR QUOTE

Document type or subject

Detailed Functional Specification – Euronext Cash Market

Revision number

3.354.0

Date

5 Mar 2025

Number of pages

113

Author

Euronext

This publication is for information purposes only and is not a recommendation to engage in investment activities. This publication is provided “as is” without representation or warranty of any kind. Whilst all reasonable care has been taken to ensure the accuracy of the content, Euronext does not guarantee its accuracy or completeness. Euronext will not be held liable for any loss or damages of any nature ensuing from using, trusting or acting on information provided. No information set out or referred to in this publication shall form the basis of any contract. The creation of rights and obligations in respect of financial products that are traded on the exchanges operated by Euronext’s subsidiaries shall depend solely on the applicable rules of the market operator. All proprietary rights and interest in or connected with this publication shall vest in Euronext. No part of it may be redistributed or reproduced in any form without the prior written permission of Euronext.

Euronext refers to Euronext N.V. and its affiliates. Information regarding trademarks and intellectual property rights of Euronext is located at www.euronext.com/terms-use.

© 2025, Euronext N.V. - All rights reserved.

PREFACE

ABOUT THIS DOCUMENT

This document provides the detailed functional specifications of the Request For Quote service, which is a feature of the Optiq® Trading Solution.

DOCUMENT AUDIENCE

This document is aimed at Business Analysts, System Designers, Software Developers, Software Testers and anyone involved in analysis of business requirements and production of functional specifications.

WHAT'S NEW?

The following lists only the most recent modification made to this revision/version. For the Document History table, see the Appendix.

REVISION NO./ VERSION NO.	DATE	CHANGE DESCRIPTION
5.354.0	05 Mar 2025	- Clarification in §2.2.2 (Trading Phase)

ASSOCIATED DOCUMENTS

Please visit www.euronext.com/it-documentation

SUPPORT

Please find below the contact details:

- Operational Client Services Desk: clientsupport@euronext.com
- Belgium +32 2 620 0585
- France +33 1 8514 8585
- Ireland +353 1 617 4289
- Netherlands +31 20 721 9585
- Portugal +351 2 1060 8585
- UK +44 20 7660 8585

TABLE OF CONTENTS

1.	FUNCTIONAL DESCRIPTION	5
1.1	Actors	6
1.2	RFQ general kinematics	7
1.2.1	RFQ confirmation	7
1.2.2	RFQ cancellation	8
1.2.3	RFQ expiration	8
1.3	Quote Request	9
1.4	RFQ Answers	10
1.5	RFQ confirmation	11
1.6	RFQ notification and matching status	12
1.6.1	RFQ notification	12
1.6.2	RFQ matching status	12
1.6.3	RFQ LP matching status	13
1.6.4	Matching status messages sending example	13
1.7	Potential Matching Quantity, Potential Matching Price and Average Price	15
1.8	Private audit	16
1.9	Publication	17
2.	PRODUCT IMPACTS	18
2.1	Order Entry Gateway	19
2.1.1	Messages	19
2.1.2	Order Type	19
2.1.3	Time In Force	20
2.1.4	RFQ submission - Dark characteristics	20
2.1.5	LP's answer	21
2.1.6	RFQ confirmation	22
2.1.7	RFQ cancellation	24
2.2	Matching Engine	25
2.2.1	RFQ validity	25
2.2.2	Trading phase	25
2.2.3	Instrument halted	25
2.2.4	LP's answer and order book	26
2.2.5	RFQ Matching Algorithm	26
2.2.6	Trades and Kill messages resulting from an RFQ execution	27
2.2.7	Collars	29
2.2.8	Maximum Order Quantity Continuous and Maximum Order Amount Continuous	32
2.2.9	Potential Matching Price	32
2.3	Market Data Gateway	35
3.	INTERFACE IMPACTS	36
3.1	Private messages	36
3.1.1	SBE	36
3.1.2	FIX	46
3.2	Public messages	57

3.2.1	Order Update (1002)	57
3.2.2	Market Update (1001)	57
3.2.3	Full Trade Information (1004)	58
3.2.4	Statistics (1009)	59
3.3	Kinematics	60
3.3.1	RFQ Rejected	60
3.3.2	RFQ Not Confirmed	61
3.3.3	RFQ Cancelled	63
3.3.4	RFQ Fully Matched	67
3.3.5	RFQ Partially Matched	74
3.3.6	RFQ with no Side	79
3.3.7	RFQ with best price rejected	87
3.3.8	LP's answer with Order Price Control Collar breach kinematics	92
3.3.9	RFQ confirmation with Order Price Control Collar breach kinematics	96
A.	APPENDIX	102
A.1.	RFQ Matching examples	103
A.1.1.	RFQ matching examples without MAQ/MES	103
A.1.2.	RFQ matching examples with MES	104
A.1.3.	RFQ matching examples with MAQ	106
A.1.4.	RFQ matching and collars	109

1. FUNCTIONAL DESCRIPTION

This document provides the detailed functional specifications of the Request For Quote service. It covers all the functionalities implemented within the Optiq Trading Solution to allow a Trading Participant to send their intentions to trade to the RFQ Liquidity Providers community.

The RFQ LP role is specific to the RFQ functionality and is additional to the regular LP role in the Central Order Book.

The Request For Quote service is available for use in the Central Order Book and enables Trading Participants to obtain the best prices from the order book and from RFQ Liquidity Providers.

1.1 ACTORS

An RFQ Issuer can be any existing trading participant that has requested this functionality.

The RFQ Issuer sends the quote request and decides whether or not to trade, depending on the answers they obtain.

The role of RFQ Liquidity Providers (referred to in this document hereon as Liquidity Providers) can be granted to any Trading Participant trading on the platform¹. Once this role has been assigned, RFQ Liquidity Providers receive all RFQ notification on all ETPs and Fixed Income instruments, and can choose whether or not to send one or several orders.

¹ On Bond-x, participants with the Broker Agency role are not permitted to also be an RFQ LP Responder.

1.2 RFQ GENERAL KINEMATICS

The RFQ trading model allows the RFQ issuer to send a quote request for a given security and quantity to registered Liquidity Providers.

An RFQ can only be raised during the continuous trading phase² and follows this general workflow (for detailed kinematics, see section [3.3](#)):

- RFQ issuer sends the quote request to Optiq
- Notifications are sent to LPs from Optiq
- A Matching Status is sent to the issuer by Optiq to inform the issuer that there is a potential matching situation for the RFQ. This message includes the potential matching quantity and its average price, computed based on orders in the COB and from LPs. This message will be resent each time an event occurs (on COB or from the LPs) that alters the potential matching quantity or the average price.
- LPs send orders with their proposed quantity, price and side. An LP can respond with several price and quantity combinations to a single request for quotes. Several LPs' orders can match simultaneously.
- An LP matching status is sent by Optiq to the LPs to let them know if their orders are competitive. This message indicates the potential matching quantity of their order and will be resent each time an event occurs (on COB or from the LPs) that alters their potential matching quantity.

Different scenarios are possible:

- RFQ confirmation
- RFQ cancellation
- RFQ expiration.

1.2.1 RFQ confirmation

The RFQ can be confirmed and may lead to a trade.

- The RFQ issuer confirms the RFQ by sending an average price order.
- LPs' answers which have not been matched are killed (with kill reason - 'LP Order cancelled due to RFQ confirmation') as well as the remaining quantities of orders which are participating in the trade (reason 'LP Order cancelled due to RFQ confirmation'). If the RFQ issuer's order has partially matched, a kill message is also sent (with kill reason - 'RFQ Remaining quantity killed').

An audit with all details about the COB orders that have matched with the RFQ and about the matching propositions from LPs is sent to the RFQ Issuer (maximum 50 offers). LPs' response details are sent whether orders have matched or not.

² The RFQ cannot be submitted during the TAL (Trading At Last) phase.

1.2.2 RFQ cancellation

The RFQ can be cancelled by a cancel request or a mass cancel sent by the RFQ issuer. In that case, kill orders are sent to the RFQ issuer (with kill reason 14 - 'RFQ cancelled by the issuer') and to all LP's which have sent an order in answer (with kill reason 20 - 'LP Order cancelled due to RFQ cancellation').

The RFQ can also be cancelled due to disconnection of the RFQ issuer. In that case two kinematics are possible regarding the sending of kill orders:

- The RFQ is cancelled first (with kill reason 11- 'Order cancelled due to cancel on disconnection mechanism'), then all LP's orders that have been sent in response to this RFQ are cancelled (with kill reason 20 'LP Order cancelled due to RFQ cancellation');
- The LP order is cancelled first (with kill reason 11- 'Order cancelled due to cancel on disconnection mechanism') and then the RFQ is cancelled (also with kill reason 11- 'Order cancelled due to cancel on disconnection mechanism').

1.2.3 RFQ expiration

The RFQ expires after 180 seconds if there has been no confirmation or cancellation.

Kill orders are sent to the RFQ issuer (with kill reason - 'RFQ expired') and to all LPs that have sent an order in response (with kill reason - 'LP Order cancelled due to RFQ expiration').

1.3 QUOTE REQUEST

A **Quote Request** is a private message sent by a trading participant, the RFQ Issuer. It contains the instrument and the requested quantity (Quantity and Minimum Quantity must respect the Lot Size of the Instrument).

The side of the request (buy or sell) is not compulsory.

Further details regarding the message content are mentioned in section 3.1.1 and 3.1.2.

1.4 RFQ ANSWER

An RFQ answer is a common **New Order** (limit order) which conveys, in addition to the price, quantity and side, the Quote Request Id in order to refer to the RFQ.

An LP order can be Lit or Dark³.

One LP can send several orders for the same RFQ with different combinations of price and quantity. These orders can be accumulated to compute the potential Matching Quantity and Price.

An RFQ answer cannot be modified directly (using a cancel/replace), but modifications can be managed by sending a cancellation followed by a new order submission (RFQ answer).

At the same price, an LP's order has priority over COB orders (Lit and Dark). The priority is then given to the greatest available quantities and finally to the first issued (earliest timestamp).

³ Dark orders are permitted and consequently are considered only if the dark functionality is activated by the market. The dark functionality will not be activated at the Borsa migration date.

1.5 RFQ CONFIRMATION

An RFQ confirmation is a common **New Order** (type 'Average Price') referring to the RFQ Identifier.

The characteristics of an RFQ cannot change when it has been confirmed, with the exception of the price, which can be worse than the potential matching price (PMP) (up to the best order participating in the PMP).

Consistency between the Quote Request and the average-priced order of validation from the RFQ Issuer will be managed thanks to the following elements:

- **Dark Indicator:** A Quote Request and its confirmation may only be Lit.
- **Sweep Order Indicator:** A Quote Request and its confirmation can request to have interaction with the dark pool. **Minimum Quantity Type:** A member cannot send in the RFQ confirmation a Minimum Quantity type different from the one stated in the initial Quote Request. The Minimum Quantity itself must remain equal to the original, and the type of restriction must remain the same as the original.
- **Quantity:** A member cannot change the original quantity of the Quote Request in the RFQ confirmation.
- **Time In Force:** The Confirmation can only be Immediate or Cancel (3).

1.6 RFQ NOTIFICATION AND MATCHING STATUS

1.6.1 RFQ notification

Once an RFQ is created and received by the Matching Engine, an **RFQ Notification message** is sent to all the registered LPs. There is no other reason for which an RFQ Notification is sent to the LPs.

This RFQ notification contains the Quantity and the Instrument of the associated RFQ.

1.6.2 RFQ matching status

The **RFQ matching status** message is sent to notify the RFQ Issuer of the possibility to match their RFQ with new COB or LP orders.

The **RFQ matching status** message contains:

- the Potential Matching Quantity (PMQ);
- the Potential Matching Price (PMP);
- the number of LP(s) responding to the RFQ.

The **RFQ matching status** message is sent to the RFQ Issuer each time there is a modification of the PMQ, and/or the PMP, and/or the number of responding LPs:

- Every time there is an RFQ LP answer;
- At the RFQ timer (which starts at the RFQ submission time, and is recalculated every 1000 ms) if the last order participating to the PMQ calculation until the next RFQ timer is a COB one (Lit or Dark).

Note: if there is no longer any LP order participating to the PMQ calculation (because of LP order cancellation or price level not reached in regards with the initial RFQ quantity available) then an RFQ matching status is explicitly sent to the RFQ issuer with number of LP equals to '0'.

Note: if there is no change in the PMQ previously allocated to the RFQ Issuer, **no RFQ matching status** message is sent.

1.6.3 RFQ LP matching status

The **RFQ LP matching status** message informs the RFQ Issuer of their possibility of trading with the RFQ.

At the **first** RFQ LP order entry, two situations are possible:

- the LP can pretend to trade (i.e. the LP order participates to the PMQ calculation). In this case an **RFQ LP matching status** message is sent immediately specifying the PMQ the LP can pretend to trade at this time.
- the LP can't pretend to trade (i.e. the LP order does not participate to the PMQ calculation). In this case **no** message is sent to the LP.

Any update in the PMQ previously allocated to this LP is notified by an **RFQ LP matching status** message which is sent:

- At the order entry/cancellation time of the LP impacting the PMQ;
- At the RFQ timer if the last order impacting the PMQ until the next RFQ timer is a COB one (Lit or Dark).

Note: if there is no change in the PMQ previously allocated to the LP, **no RFQ LP matching status** message is sent.

1.6.4 Matching status messages sending example

Assume the following order book:

Bid				Offer					
Firm	Seq	Quantity	Price	Price	Quantity	Seq	Firm		
Quote Request	Broker ₁	1	100	N/A	100	10	2 - 9	Broker ₂	COB Order
				101	50	3 - 4 - 5 - 7	LP _A		RFQ LP answer
				102	90	6	LP _B		RFQ LP answer
				103	50	8	LP _C		RFQ LP answer

Overall scenario:

1. Broker₁ enters a quote request to buy 100 shares.
2. Broker₂ enters a sell (COB) order for 10 shares at price 100.
3. LP_A answers to the RFQ with a sell limit order for 50 shares at price 101.
4. LP_A cancels its RFQ answer.
5. LP_A answers to the RFQ with a sell limit order for 50 shares at price 101.
6. LP_B answers to the RFQ with a sell limit order for 90 shares at price 102.
7. LP_A cancels its RFQ answer.
8. LP_C answers to the RFQ with a sell limit order for 50 shares at price 103.
9. Broker₂ cancels its (COB) order.

Based on this scenario, the following diagram illustrates the sending of matching status messages to the RFQ issuer and to the RFQ responding LPs :

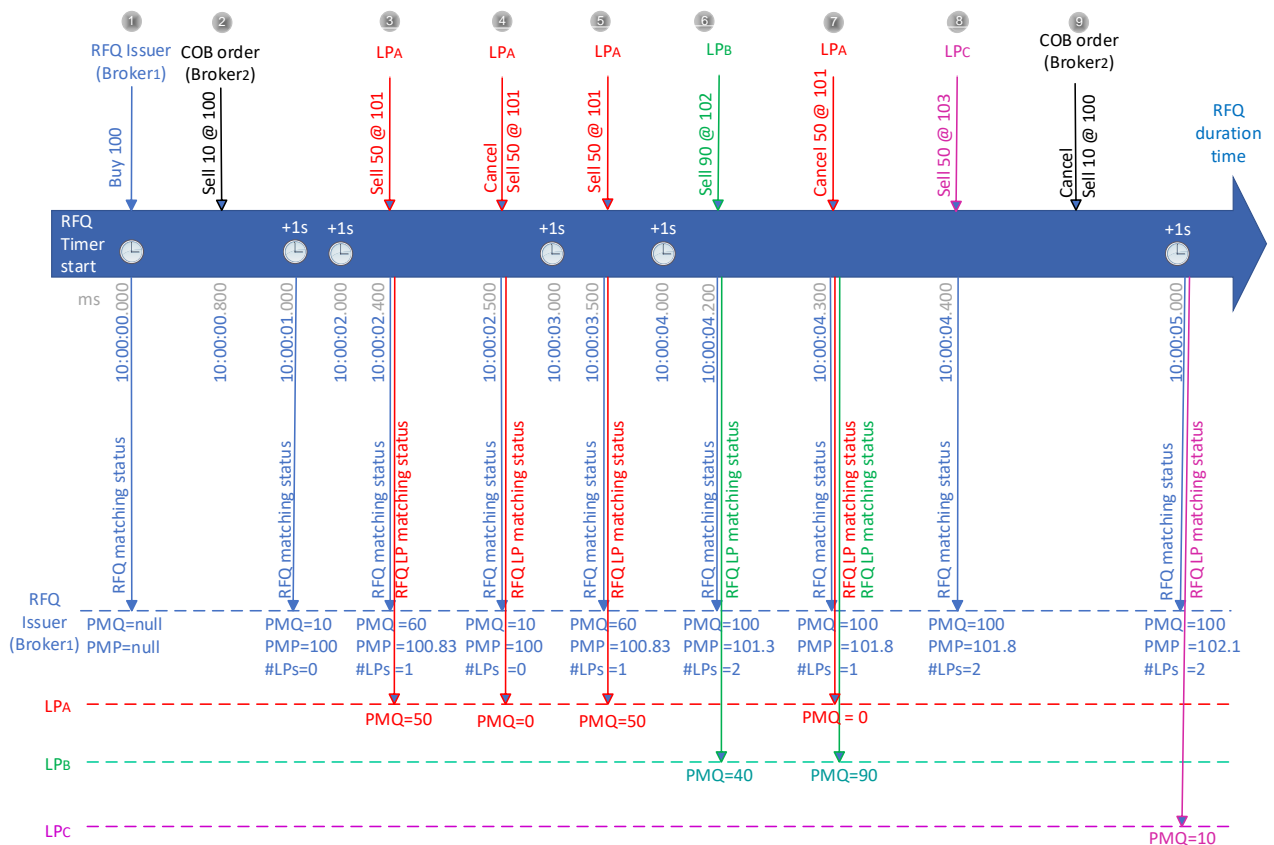

1.7 POTENTIAL MATCHING QUANTITY, POTENTIAL MATCHING PRICE AND AVERAGE PRICE

At each event occurring regarding the RFQ (a new LP answer or new COB order), the **Potential Matching Quantity** will be computed taking into account the quantity available for the best prices of all offers, respecting the minimum acceptable quantity (MAQ) or minimum execution size (MES).

The **Potential Matching Price** results from the weighted average of those best prices multiplied by the corresponding quantity (for each order).

This price is guaranteed for the RFQ issuer, but not the quantity.

The Potential Matching Price and the associated Potential Matching Quantity are computed based on the following priority rules:

- Price
- Transparency⁴
- Quantity (including MAQ or MES)
- Timestamp.

The **Average Price** is the limit price that the RFQ issuer is willing to trade with, and is the price indicated in the RFQ confirmation by the RFQ Issuer. Not all generated trades are necessarily at this price. The Potential Matching Price and the Average Price do not necessarily need to be compliant with the tick size. Effectively, they are average prices and trades resulting from an RFQ execution coming from orders with decimals compliant to the tick size.

⁴ Only if Dark Pool is activated by the market

1.8 PRIVATE AUDIT

If the RFQ is confirmed, a private **RFQ Audit** message is sent to the RFQ Issuer. The RFQ Audit message contains the order type (COB or LP), the Last Traded Quantity, the Remaining Quantity, the MAQ or the MES, and the price of the fifty best orders. Only COB orders that have matched are sent, while LPs answers are included in the message whether they have matched or not.

1.9 PUBLICATION

After each RFQ confirmation, cancel or expiration, each Lit LP answer received is published to the market.

Every order is published, independently of its side: both sell and buy orders will all be published after a no-side RFQ.

Orders that have been cancelled are published as well.

2. PRODUCT IMPACTS

2.1 ORDER ENTRY GATEWAY

2.1.1 Messages

The following messages are sent during the full RFQ Workflow.

Their content is further detailed in section [3. Interface Impacts](#).

Message	SBE/FIX message
RFQ Sending	Quote Request (10) (R)
RFQ Notification	RFQ Notification (35) (U35)
RFQ Matching Status	RFQ Matching Status (36) (U36)
RFQ LP Matching Status	RFQ LP Matching Status (37) (U37)
LP's Answer	New Order (01) (D) message with order type set to 2 for 'Limit'
RFQ confirmation	New Order (01) (D) message with order type set to 9 for 'Average Price'
RFQ Cancel	Cancel Request (12) (F) or Mass Cancel (13) (q)
Kill Order	Kill (05) (8)
RFQ Expiration	Kill (05) (8)

2.1.2 Order Type

2.1.2.1 SBE

- Order Type can only be '2' Limit for LPs' New Order (01).
- Order Type can only be '9' Average Price for RFQ Issuers' New Order (01).

If	Then
RFQ Answer = Yes	Order Type = Limit
RFQ Confirmation = Yes	Order Type = Average Price

2.1.2.2 FIX

- OrdTyp can only be '2' Limit for LPs' NewOrderSingle (D).
- OrdTyp can only be 'T' Average Price for RFQ Issuers' NewOrderSingle (D).

If	Then
RFQAnswerIndicator = Yes	OrdType = Limit
RFQConfirmationIndicator = Yes	OrdType = Average Price

2.1.3 Time In Force

2.1.3.1 SBE

- Time In Force is checked during the order entry for LP's New Order (01) and must be 'Day'.
- Time In Force can only be '3' Immediate Or Cancel for RFQ Issuers' New Order (01)

If	Then
RFQAnswerIndicator = Yes	TimeInForce = Day
RFQConfirmationIndicator = Yes	TimeInForce = Immediate Or Cancel
RFQConfirmationIndicator = Yes TimeInForce != Immediate Or Cancel	Reject for Invalid "Time In Force" (3015)
RFQAnswerIndicator = Yes TimeInForce != Day	Reject for Invalid "Time In Force" (3015)

2.1.4 RFQ submission - Dark characteristics⁵

An RFQ can only be Lit with Dark interaction.

Technically:

Quote Request Dark Execution Instruction field	Value
Dark Indicator	No
Sweep Order Indicator	Yes

Error code 3627 will be raised (Invalid Dark Execution Instruction) to reject a quote request if these criteria are not respected.

An RFQ Issuer is permitted to request a Minimum Execution Size on an RFQ, without raising the error 2074 ([Dark Execution Instruction]: Invalid 'Dark Indicator'/ 'Minimum Quantity Type' combination).

Technically:

If	Then
Quote Request (10) (R)	MinQtyType can be either MAQ or MES
RFQ Confirmation (SBE)/ RFQConfirmationIndicator (FIX) = Yes	MinQtyType can be either MAQ or MES

2.1.5 LP's answer

LPs' answers are dedicated to a unique RFQ. They cannot match with other orders (wherever COB or Dark orders) and they are killed at the end of the RFQ. An LP Answer must respect the following conditions:

- Lot size and Instrument tick must be respected;
- The instrument must be open (Book state is continuous);
- The firm should be authorised on the Trading Group to which the instrument belongs;
- The Trading Member must be registered as an RFQ Responder on this instrument.

There are different error codes for LP answer order entry:

If	Then
QuoteReqID empty and RFQ Answer = Yes	3647 (Invalid QuoteReqID)
Answer with other order type than Limit	2090 (Forbidden Order Type for RFQ Answer)
Answer with AccountType other than LP	3003 (Invalid Account Type)
Answer with LPRole other than RFQ Liquidity Provider	1041 (Invalid LP Role for RFQ Answer)
Answer to unknown QuoteReqID (expired, incorrect)	2515 (Unknown QuoteReqID)
Trading Member not registered as RFQ Responder on Symbol	2256 (Firm must be an RFQ Responder)
Answer to same side than the RFQ	3011 (Invalid order side)
Phase different from Continuous	2515 (Unknown QuoteReqID)

The CancelOnDisconnect mechanism is available for LPs' Answer. This is optional, in the same way as for COB NewOrders (via the ExecutionInstruction).

After the RFQ Matching, all booked answers which have not matched are killed. The Member receives a Kill message for each order still in the book.

For each **Kill message** sent, a *Reason* is specified:

Kill Reason Code	Reason	Triggered by
12	RFQ Expired	No RFQ Confirmation before 180sec
14	RFQ Cancelled by the Issuer	RFQ Issuer cancelling the RFQ
14	RFQ Cancelled by the Issuer	RFQ Issuer logged out
19	LP Order cancelled due to RFQ expiration	RFQ Expired
20	LP Order cancelled due to RFQ cancellation	RFQ Cancelled
22	LP Order cancelled due to RFQ confirmation	RFQ confirmed its quantity with other orders

2.1.6 RFQ confirmation

The RFQ Confirmation is sent through a **New Order** with *Order Type* = AveragePrice (9) and *Time in Force* = IOC (3).

This message must respect the following conditions:

- Lot size must be respected;
- The instrument must be open (Book state is continuous);
- The firm should be authorised on the Trading Group to which the instrument belongs;

However, since an RFQ Confirmation is an average price of several orders respecting the tick table, it does not have to respect the tick table itself.

Here are the mandatory fields for the RFQ Confirmation by the RFQ Issuer:

Field	Value
Order Type	'9' - Average Price
QuoteReqID	Provided and Valid
Order Price	Provided and > 0
Execution Instruction	RFQ Confirmation = Yes
Time In Force	'3' - Immediate Or Cancel

The **New Order** Confirmation cannot change the following RFQ characteristics:

- FirmID
- Quantity
- MinOrderQty
- DarkExecInst.

Errors are raised in the following conditions:

If	Then
OrderType \neq 9 (AveragePrice)	2084 (Invalid [Dark Execution Instruction] 'Displayed Order Interaction')
QuoteReqID invalid (NullValue or does not match pending quotes)	3647 (Invalid QuoteID)
Time In Force \neq IOC (3)	3015 (Invalid Time In Force)
Dark Indicator = Yes	3627 (Invalid Dark Execution Instruction)
Sweep Indicator = No	3627 (Invalid Dark Execution Instruction)
Order Type = AveragePrice and RFQConfirmationIndicator not set to Yes	4541 (Missing Conditional RFQ Confirmation Indicator)
QuoteReqID \neq NullValue and RFQConfirmationIndicator not set to Yes	3647 (Invalid QuoteReqID)
RFQ Firm \neq NewOrder Firm	1046 (Invalid QuoteReqID For RFQ Confirmation)
RFQ Quantity \neq NewOrder Quantity	3642 (Invalid Order Quantity)
RFQ MinQty \neq NewOrder MinQty	3633 (Invalid Minimum Order Quantity)
RFQ DarkExecInst \neq NewOrder DarkExecInst	3627 (Invalid Dark Execution Instruction)
RFQ Side \neq NewOrder Side	3011 (Invalid Order Side)
RFQ confirmation average price < best offer price participating to the PMP at sell side or RFQ confirmation average price > best bid price participating to the PMP at buy side	2029 (No shares available within collars (IOC/FOK/MinQty))
RFQ confirmation average price is empty	4578 (Missing order price)
RFQ confirmation average price is \leq 0	2094 (Negative price forbidden)

If the New Order is rejected because of one of these error codes, its fields are not saved by the matching engine.

In other cases, the order is injected in the Central Order Book.

Some characteristics of the RFQ are overridden by the New Order's fields, which are used in matching messages:

- OESessionID
- AccountType
- LPRole
- MifidIndicators

All messages after the Matching will be sent through this New Order's OESessionID.

If the RFQ issuer order does not fully match, its message is killed:

Kill Reason Code	Reason	Triggered by
21	RFQ Remaining quantity killed	Order does not fully matched

Note: The STP functionality is not checked on RFQ confirmation

2.1.7 RFQ cancellation

A member can cancel a pending RFQ using the Cancel Request message:

SBE Field	Value provided by the member
OrderID	RFQID
CancelExecutionInstruction	QuoteRequest (3)

A member can also cancel a pending RFQ with the Member MassCancel message. All cancelled RFQs will be counted in the "TotalAffectedOrders" field in the MassCancelAck.

2.2 MATCHING ENGINE

2.2.1 RFQ validity

A Quote Request is valid for 180 seconds (parameter).

A member message raised after the Quote Request expiration is rejected with the error code 2515 'Unknown QuoteReqId'. This can occur in the following cases:

- If any LP replies to the expired quote request with the New Order message;
- If any RFQ Issuer tries to confirm its expired RFQ with the New Order message;
- If any RFQ Issuer tries to modify its expired RFQ with the Cancel Replace message.

RFQs are always killed if a Cancel On Disconnect is activated. At a Cancel On Disconnect, the engine sends a Kill message for the RFQ to the RFQ issuer (see §1.2.2 RFQ cancellation).

An RFQ can be cancelled by the RFQ Issuer through the Cancel Request Message (10). The RFQ issuer must set the CancelExecutionInstruction to 3 (Quote Request) in order to cancel a pending RFQ. The ID of the RFQ is to be set in the OrderID field.

2.2.2 Trading phase

An RFQ can only be raised during the Continuous trading phase and should be raised at least 180 seconds before the end of the phase (RFQ cannot be processed when submitted 3 minutes before the end of the Continuous phase, and as such, if submitted after 3 minutes and before Continuous ends, will be cancelled at the end of the Continuous).

In order to prevent any RFQ persisting into the Auction trading phase, all RFQs are deleted with Kill (05) (8) message when changing phase from Continuous trading to Auction. The RFQ Issuer receives the Kill Reason 'RFQ Expired' (12) and any LP that has answered the RFQ receives the Kill Reason 'LP Order Cancelled Due To RFQ Expiration' (19).

2.2.3 Instrument halted

All RFQs on a specific instrument are deleted with the Kill (05) (8) message once this instrument is halted.

An RFQ cannot halt the instrument concerned and will not demand breach confirmation. Trades resulting from an RFQ have their price inside the collars.

The Kill Reason received by the member is the same as the kill during the changing phase. The RFQ Issuer receives the Kill Reason 'RFQ Expired' (12) and any LP that has answered the RFQ receives the Kill Reason 'LP Order Cancelled Due To RFQ Expiration' (19).

2.2.4 LP's answer and order book

An LP's answer cannot match against any existing orders in the order book; it can only match against the potential incoming order from the RFQ issuer which refers to the RFQ Identifier. Both New Order messages must have the same QuoteReqID in order to match.

2.2.5 RFQ Matching Algorithm⁶

During the matching process following a confirmation, the engine matches the full quantity while the *average price* of matching will not exceed the member average price. The quantity is maximised.

At each matching, the engine reprices the average price (average between the matching price and the matched quantity) in order to not exceed the RFQ issuer order price.

As an RFQ can match with Lit RFQ LP answers, Dark RFQ LP answers, Lit orders and Dark orders, the following execution priority rules are processed on RFQ matching:

1. **For an identical price**, the priority is based on:
 - 1.1. **Lit RFQ LP answers**,
 - 1.2. **Dark RFQ LP answers**,
 - 1.3. **Lit orders (COB)**,
 - 1.4. **Dark orders (COB with Dark)**.

2. **Between RFQ LP answers**, the priority is based on:
 - 2.1. **Price**: from the best price to the worst price (best price for a buy order is the highest price, best price for a sell order is the lowest price),
 - 2.2. **Transparency**: Lit orders have a higher ranking than Dark orders,
 - 2.3. **Quantity** (including MAQ/MES): orders with a higher quantity have priority,
 - 2.4. **Time**: orders with a lower (older) timestamp have higher priority, orders with a higher (newer) timestamp have lower priority.

3. **Between COB orders**, the priority is based on:
 - 3.1. **Price**: from the best price to the worst price (best price for a buy order is the highest price, best price for a sell order is the lowest price),
 - 3.2. **Transparency**: Lit orders have a higher ranking than Dark orders,

⁶ Dark orders are only permitted and consequently only considered if the dark functionality is activated by the market. The dark functionality will not be activated at the Borsa migration date.

- 3.3. **Time:** orders with a lower (older) timestamp have higher priority, orders with a higher (newer) timestamp have lower priority.

It is never possible to trade orders with best priority through the COB.

A resting Market Order in the COB on the contra side of the RFQ prevents the RFQ from matching with any orders be them regular limit COB orders, or LP answers, no matter their price (Potential Matching Price will always be 0 until the Market Order disappears from the contra side).

MAQ and MES minimum quantities must be respected on each side (RFQ issuer and its potential counterparty) without skipping COB prices.

From the Requestor's point of view, MAQ and MES have different "meanings": MAQ="minimum-acceptable-quantity" in aggregate, even with multiple counterparties, while MES="minimum-execution size" allowed per order/response of each counterparty.

However, this is not the case for the Responder, who can respond with either MAQ or MES, which both produce the same effect. In any case the Responder can only match with one counterparty, and MAQ or MES specify only the minimum quantity that the Responder allows to trade.

If the Requestor enters a MES (or MAQ) constraint, the Responder can enter its own constraint (could be MAQ or MES).

Examples of matching with or without MAQ/MES are included in the Appendix sections:

- A.1.1 RFQ matching examples without MAQ/MES
- A.1.2 RFQ matching examples with MES
- A.1.3 RFQ matching examples with MAQ

2.2.6 Trades and Kill messages resulting from an RFQ execution

An RFQ can be executed against several LPs' orders and COB orders. Hence there might be more than one trade generated for an RFQ confirmation.

Each Trade is published separately.

2.2.6.1 Complete Matching

Fill (04) (8) messages are sent to the orders having matched, respectively. Any LP orders that have not matched are killed via a **Kill** (05) (8) message with *Kill Reason* 'LP Order cancelled due to RFQ confirmation' (22).

2.2.6.2 Partial Matching

After a partial matching, the remaining quantities of the **New Order** 01 (D) are killed via a **Kill** (05) (8) message sent to the RFQ issuer for the remaining quantity with *Kill Reason* set to 'RFQ Remaining quantity killed' (21).

Any LP answers which have not matched fully are also killed with *Kill Reason* 'LP Order cancelled due to RFQ confirmation' (22).

2.2.6.3 No Matching

Since the RFQ Confirmation is an *Immediate Or Cancel*, if the engine cannot match any quantity (caused by an Average Price that is too low or a MAQ that has not been respected, etc ...), the **New Order** 01 (FIX D) is rejected with error code 2029 '*No Share Available Within Collars IOC FOK MinQty*'. This reject cancels the RFQ and all LP answers are killed with *Kill Reason* 'LP Order cancelled due to RFQ confirmation' (22).

2.2.7 Collars

2.2.7.1 Type of collars

When an RFQ is matched, the collars applied depend on the type of LP answers.

- In the case of a Lit LP order: the OPC, dynamic and static collar mechanisms will be applied (RFQs will be subject to the same collars in place for the Lit Central Order Book)
- In the case of a Dark LP order: the dark collar mechanism will be applied.

2.2.7.2 Last Traded Price

An RFQ Trade is considered to be a trade between an RFQ confirmation and an RFQ LP answer.

In the case of an RFQ trade:

- The Last Trade Price is not updated;
- The flag as first trade is not set;
- Stop orders are not triggered;
- The Dynamic Collar Reference Price is not updated, and dynamic collars are not updated;
- The Static Collar Reference Price is not updated, and static collars are not updated;
- The Closing Price is not updated;
- The Official Price is not updated;
- The prices in MDG statistics are not updated
- The NCA REFPRI file is not updated.

A trade occurring between an RFQ issuer and an order from the COB is considered as a conventional trade. In this case:

- The Last Trade Price is updated;
- The flag as first trade can potentially be set;
- Stop orders can potentially be triggered;
- Both the Dynamic Collar Reference Price and dynamic collars are updated;
- The Static Collar Reference Price and static collars are updated only in case of the first trade on the COB, not updated otherwise;
- The Closing Price is updated;
- The Official Price is updated;
- MDG statistics are updated;
- The Reference Price file for regulators (REFPRI) is impacted.

Note:

At clearing level, this level of detail (new trade type) regarding the order execution is not essential information for the compensation. The most important for the CCP is to identify the counterparties involved in trades with prices, quantities, etc, which is the case.

2.2.7.3 Behaviour of orders outside of collars

RFQ answers will be considered as regular orders to determine the behaviour outside the collars:

- Lit LP answers will be considered as Lit orders.
- Dark LP answers will be considered as Dark orders.

During the matching process, as soon as an RFQ confirmation tries to match with a Lit order that is outside the OPC collar, or the dynamic collars, or the static collars:

- If it is a COB Lit order, then
 - The trade with this order is not executed;
 - All the next Lit orders will be ignored for this RFQ matching (as there is a better COB Lit price);
 - The RFQ confirmation can match with other Dark orders within the dark collars.
- If it is an RFQ LP Lit order, then
 - The trade with this order is not executed;
 - The RFQ confirmation can match with other Lit or Dark orders within the collars.

During the matching process, as soon as an RFQ confirmation tries to match with a Dark order outside the dark collars:

- This Dark order outside the collars is ignored;
- The trade with this order is not executed;
- The RFQ confirmation can match with the next orders (both Lit and Dark orders) within the collars.

If the best Lit order is outside the collars, then no Lit order (even within the collars) will match during this RFQ matching.

Example 2.2.7.3.1 – Dark RFQ LP answer out of collars, Dark order within collars

RFQ Confirmation is sent with:

- Dark RFQ LP answer out of collars
- Dark order within collars

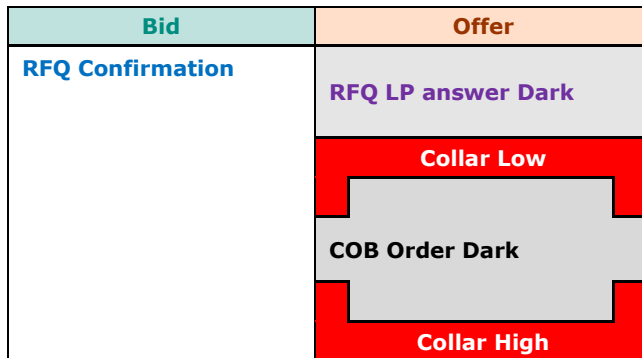

Behaviour: RFQ will bypass the Dark RFQ LP answer, and will match with the Dark order

Example 2.2.7.3.2 – LP Lit out of collars, Lit within collars

RFQ Confirmation is sent with:

- LP Lit out of collars
- LIT order within collars

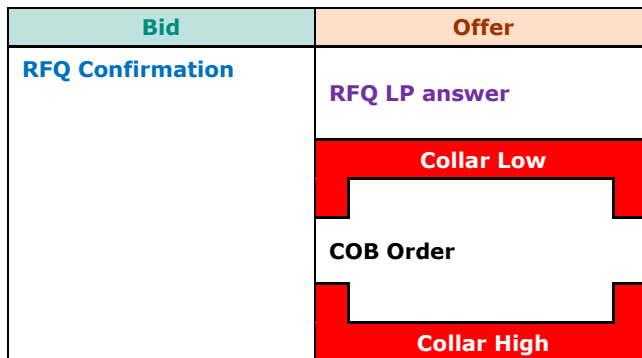

Behaviour: RFQ will bypass the RFQ LP answers outside of collars and will match with the COB orders inside the collars.

Example 2.2.7.3.3 – (LIT) RFQ LP answer out of collars, (LIT) COB order within collars, Dark RFQ LP answer within collars, Dark COB order within collars

RFQ Confirmation is sent with:

- (LIT) RFQ LP answer out of collars
- (LIT) COB order within collars
- Dark RFQ LP answer within collars
- Dark COB order within collars

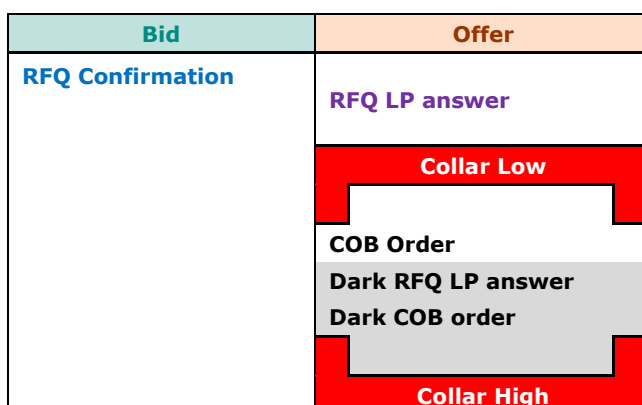

Behaviour: RFQ will bypass the RFQ LP answers outside of collars and will match with the others (priority for LPs) inside the collars.

Examples of matching outside of collars are included in the Appendix sections:

- A.1.4 RFQ matching and collars

2.2.8 Maximum Order Quantity Continuous and Maximum Order Amount Continuous

The matching engine checks the Maximum Order Quantity Continuous and Maximum Order Amount Continuous (the COB level parameters available on referential files) on the following private messages:

- RFQ submission message;
- RFQ confirmation message;
- RFQ LP answer message.

The total quantity is mandatory in the RFQ submission and new order entry messages (RFQ confirmation & RFQ LP answer). The total and minimum quantities of an order must be:

- Positive values;
- Multiples of the instrument's board lot size;
- Strictly less⁷ than n shares as defined by the parameter Maximum Order Quantity Continuous.

The total amount of an order (price × total quantity⁸) should be strictly less than the Maximum Order Amount Continuous.

As an RFQ submission does not contain the price, the Dynamic Collar Reference Price is taken into account to compute the amount.

If the dynamic collar logic is disabled, then the system uses the LACP.

2.2.9 Potential Matching Price

For the RFQ Matching Status (36) (U36) message, the Potential Matching Price sent to the RFQ Issuer ignores orders outside of collars.

The calculation of the Potential Matching Price (PMP) is the weighted average price of orders within the collars for the asked quantity. The Potential Matching Price should also

⁷ For Fixed Income, this is less or equal to the maximum order quantity

⁸ For Fixed Income, the total amount checked is (price × total quantity) / 100

be sent when there is an update of the BBO (because it could lead to an order inclusion/exclusion from the dynamic collars limits).

The PMP is updated and sent to the RFQ issuer when:

- A new LP answer enters in the book (with price or a quantity updated);
- At the RFQ timer (which starts at the RFQ submission time, and is recalculated every 1000 ms) if the last order participating to the PMQ calculation until the next RFQ timer is a COB one (Lit or Dark). Timer: 1000ms

While the orders are within the collars, the PMP will take all the order to maximise its quantity and begin with the best order until its quantity is complete or no more orders are available.

- The Best Order on Buy side is the highest one.
- The Best Order on Sell side is the lowest one.

The Potential Matching Price for this RFQ with a quantity 100 is:

$$PMP = \frac{(\text{Qty Best Order 1} \times \text{Price Best order 1}) + \dots + (\text{Qty Best Order n} \times \text{Price Best Order n})}{\text{Qty Best Order 1} + \dots + \text{Qty Best Order n}}$$

Example:

Assume the initial order book is as follows:

Bid				Offer			
Firm	Seq	Quantity	Price	Price	Quantity	Seq	Firm
Broker A	1	100	-	100	10	4	LIT 3
				101	100	3	LIT 2
				102	90	2	LIT 1

$$PMP = \frac{(10 \times 100) + (90 \times 101)}{10 + 90} = 100,9$$

This potential Matching Price will be sent to the RFQ Issuer with the Potential Matching Quantity in the **RFQ Matching Status** 36(U36) message.

The RFQ Issuer can confirm its RFQ with a Price = 101 to be sure to match.

Trade Price Case

Notice that as long as the Average Matching Price is inferior or equal to the Member Price (*asked Price* in the RFQ Confirmation), trades prices can exceed the Member Price.

It is possible for the single trade price to be superior to the Member Price (RFQ confirmation) because it is an average price and the order is not limited.

Example:

Assume the initial order book is as follows:

Bid				Offer			
Firm	Seq	Quantity	Price	Price	Quantity	Seq	Firm
Broker A	1	200	-	98	10	5	LP 1
				99	50	4	LP 2
				100	100	3	LIT 2
				105	80	2	LIT 1

$$PMP = \frac{(10 \times 98) + (50 \times 99) + (100 \times 100) + (40 \times 105)}{10 + 50 + 100 + 40} = 100,65$$

The RFQ Issuer can confirm its RFQ with a price equal to 101 to be sure to match. Each trade will be published with its quantity and price:

- Trade 1: RFQ trade with Order ID: 5; Quantity = 10; Price= 98
- Trade 2: RFQ trade with Order ID: 4; Quantity = 50; Price= 99
- Trade 3: RFQ trade with Order ID: 3; Quantity = 100; Price= 100
- Trade 4: RFQ trade with Order ID: 2; Quantity = 40; Price= 105
- Notice that the Price of Trade 4 > RFQ Price is allowed.

The quantity of the RFQ is satisfied (200/200).

Here is the state of the book after the matching of the RFQ:

Bid				Offer			
Firm	Seq	Quantity	Price	Price	Quantity	Seq	Firm
				105	40	2	LIT 1

2.3 MARKET DATA GATEWAY

The initial RFQ is never published by the Market Data Gateway.

At the end of the RFQ (confirmation, cancellation, or expiration of the request), only trades and Lit LP orders are published.

Deferred Publication is not allowed on RFQ.

All trades are published immediately on the Market Data when they occur.

Other orders that have been cancelled or that have not matched are also published.

3. INTERFACE IMPACTS

3.1 PRIVATE MESSAGES

3.1.1 SBE

3.1.1.1 Quote Request (10)

Client ► OEG

Available for: 

Message Usage:

The **Quote Request** (10) message is used by the clients to indicate their intention in a specified instrument.

Fields *Order Side* and *End Client* are optional as the client may or may not specify those parameters depending of the nature of the request.

Field	Short Description	Format	Length	Values	Presence
Client Message Sequence Number	The Client Message Sequence Number is mandatory for all inbound messages, but the consistency of the sequence is not checked by the Exchange.	Sequence	4	From 0 to $2^{32}-2$	Mandatory
Firm ID	Identifier of the member firm that sends the message.	Alphanumeric ID	8	(See field description)	Mandatory
Message Sending Time	Indicates the time of message transmission, the consistency of the time provided is not checked by the Exchange. (Time in number of nanoseconds since 01/01/1970 UTC)	Epoch Time in Nanoseconds	8	From 0 to $2^{64}-2$	Mandatory
ExecutionWithin FirmShortCode	MiFID II short code, Execution within firm, identifier of the trader or algorithm responsible for the execution making.	Numerical ID	4	From $-2^{31}+1$ to $2^{31}-1$	Mandatory
ClientIdentificationShortCode	MiFID II short code, Client identification code.	Numerical ID	4	From $-2^{31}+1$ to $2^{31}-1$	Conditional
Client Order ID	An identifier of a message assigned by the Client when submitting an order to the Exchange.	Numerical ID	8	From $-2^{63}+1$ to $2^{63}-1$	Mandatory
Order Quantity	Total order quantity, per quantity unit.(To be calculated with Quantity Decimals)	Quantity	8	From 0 to $2^{64}-2$	Mandatory

Field	Short Description	Format	Length	Values	Presence
Symbol Index	Exchange identification code of the instrument.	Numerical ID	4	From 0 to 2 ³² -2	Mandatory
EMM	Defines the Exchange Market Mechanism applied on each platform.	Enumerated	1	(See field description)	Mandatory
Order Side	Indicates the side of the order.	Enumerated	1	1 = Buy 2 = Sell	Optional
Firm ID Publication	Indicates whether the client accept or not to provide its Firm ID to the RFQ recipients. (0:No; 1:Yes)	Boolean	1	0 = False 1 = True	Mandatory
End Client	Optional field the client may use to provide the BIC of the End Client of the RFQ.	Alphanumeric ID	11	(See field description)	Optional
Dark Execution Instruction	Field used as instruction for dark order handling. Values specified, in the list of possible values, indicate the bit positions that should be used to set zero (0) or one (1) values. A single field contains multiple values provided in different positions.	Bitmap	1	0 = Lis Indicator 1 = Deferred Trade Indicator 2 = Lis/Lit Interaction 4 = Minimum Quantity Type	Optional
Minimum Order Quantity	Minimum quantity to be executed upon order entry (else the order is rejected), (To be calculated with Quantity Decimals).	Quantity	8	From 0 to 2 ⁶⁴ -2	Optional
Account Type	Indicates the account type for which the order is entered. For example, an order can be entered for a client account, a house account or a liquidity provider account.	Enumerated	1	(See field description)	Mandatory

3.1.1.2 RFQ Notification (35)

Client ◀OEG

Available for: FUND

Message Usage:

The **RFQ Notification** (35) message is sent by the trading engine to inform Liquidity Providers about the new RFQ characteristics previously received from an RFQ issuer (Client that sent the RFQ) through the **Quote Request** (10) message.

This message is sent to all Liquidity Providers registered for the dedicated instrument.

Field	Short Description	Format	Len	Values	Presence
Message Sequence Number	Indicates the Message Sequence Number per OE Session. (for messages sent by the Exchange)	Sequence	4	From 0 to 2 ³² -2	Mandatory
Firm ID	Identifier of the member firm that sends the message.	Alphanumeric ID	8	(See field description)	Mandatory
Book IN Time	Matching Engine IN time (in ns), time at which the corresponding inbound message entered the Matching Engine. (Time in number of nanoseconds since 01/01/1970 UTC)	Epoch Time in Nanoseconds	8	From 0 to 2 ⁶⁴ -2	Mandatory
Book OUT Time	Matching Engine OUT time (in ns), when message leaves the Matching Engine (Time in number of nanoseconds since 01/01/1970 UTC).	Epoch Time in Nanoseconds	8	From 0 to 2 ⁶⁴ -2	Conditional
OEG IN From ME	Gateway IN time from ME (in ns), measured when outbound message enters the gateway (Time in number of nanoseconds since 01/01/1970 UTC).	Epoch Time in Nanoseconds	8	From 0 to 2 ⁶⁴ -2	Conditional
OEG OUT To Member	Order Entry Gateway OUT time to member (in ns), measured when outbound message leaves the gateway (Time in number of nanoseconds since 01/01/1970 UTC).	Epoch Time in Nanoseconds	8	From 0 to 2 ⁶⁴ -2	Conditional
QuoteReqID	Numerical RFQ identifier assigned by the matching engine, unique per instrument and EMM.	Numerical ID	8	From 0 to 2 ⁶⁴ -2	Mandatory
Order Quantity	Total order quantity, per quantity unit. (To be calculated with Quantity Decimals)	Quantity	8	From 0 to 2 ⁶⁴ -2	Mandatory
Counterpart Firm ID	ID of the Counterpart Firm in specific cases.	Alphanumeric ID	8	(See field description)	Optional
Symbol Index	Exchange identification code of the instrument.	Numerical ID	4	From 0 to 2 ³² -2	Mandatory
EMM	Defines the Exchange Market Mechanism applied on each platform.	Enumerated	1	(See field description)	Mandatory

Field	Short Description	Format	Len	Values	Presence
RFQ Update Type	Indicates the current status of the RFQ.	Enumerated	1	1 = New 2 = Cancelled by the RFQ issuer 3 = Expired 4 = Partially or Fully Matched	Mandatory
Order Side	Indicates the side of the order.	Enumerated	1	1 = Buy 2 = Sell	Optional
End Client	Optional field the client may use to provide the BIC of the End Client of the RFQ.	Alphanumeric ID	11	(See field description)	Optional
Dark Execution Instruction	Indicate the Minimum Quantity Type for the RFQ associated.	Bitmap	1	0 = Lis Indicator 1 = Deferred Trade Indicator 2 = Lis/Lit Interaction 4 = Minimum Quantity Type	Mandatory
Minimum Order Quantity	Indicate the minimum quantity to be executed at the RFQ matching.	Quantity	8	From 0 to 2 ⁶⁴ -2	Optional
Account Type	Indicates the account type for which the order is entered. For example, an order can be entered for a client account, a house account or a liquidity provider account.	Enumerated	1	(See field description)	Mandatory

3.1.1.3 RFQ Matching Status (36)

Client ◀OEG

Available for: FUND

Message Usage:

The **RFQMatchingStatus** (36) message is sent by the trading engine to inform the RFQ issuer about the potential matching situation at the time the message is sent.

The Field *Potential Matching Price* will contain the matching price related to the *Potential Matching Quantity*.

Field	Short Description	Format	Len	Values	Presence
Message Sequence Number	Indicates the Message Sequence Number per OE Session. (for messages sent by the Exchange)	Sequence	4	From 0 to 2 ³² -2	Mandatory
Firm ID	Identifier of the member firm that sends the message.	Alphanumerical ID	8	(See field description)	Mandatory
Book IN Time	Matching Engine IN time (in ns), time at which the corresponding inbound message entered the Matching Engine. (Time in number of nanoseconds since 01/01/1970 UTC)	Epoch Time in Nanoseconds	8	From 0 to 2 ⁶⁴ -2	Mandatory
Book OUT Time	Matching Engine OUT time (in ns), when message leaves the Matching Engine (Time in number of nanoseconds since 01/01/1970 UTC).	Epoch Time in Nanoseconds	8	From 0 to 2 ⁶⁴ -1	Conditional
OEG IN From ME	Gateway IN time from ME (in ns), measured when outbound message enters the gateway (Time in number of nanoseconds since 01/01/1970 UTC).	Epoch Time in Nanoseconds	8	From 0 to 2 ⁶⁴ -1	Conditional
OEG OUT To Member	Order Entry Gateway OUT time to member (in ns), measured when outbound message leaves the gateway (Time in number of nanoseconds since 01/01/1970 UTC).	Epoch Time in Nanoseconds	8	From 0 to 2 ⁶⁴ -1	Conditional
QuoteReqID	Numerical RFQ identifier assigned by the matching engine, unique per instrument and EMM.	Numerical ID	8	From 0 to 2 ⁶⁴ -2	Mandatory
Potential Matching Price	The Potential Matching Price indicates to the RFQ issuer the matching price for the "Potential Matching Quantity".	Price	8	From -2 ⁶³ to 2 ⁶³ -1	Conditional
Potential Matching Quantity	The potential matching quantity indicates the maximum volume that would be matched in case of an RFQ validation.	Quantity	8	From 0 to 2 ⁶⁴ -2	Mandatory
Symbol Index	Exchange identification code of the instrument.	Numerical ID	4	From 0 to 2 ³² -2	Mandatory

Field	Short Description	Format	Len	Values	Presence
EMM	Defines the Exchange Market Mechanism applied on each platform.	Enumerated	1	(See field description)	Mandatory
Order Side	Indicates the side of the order.	Enumerated	1	1 = Buy 2 = Sell	Mandatory
Number Of LPs	Indicates the number of LP answers to the RFQ (whatever they can be executed or not)	Numerical	1	From 0 to 2^8-1	Conditional
Recipient Type	Indicates whether the message is sent to the RFQ Issuer or the Liquidity Provider	Enumerated	1	1 = RFQ Issuer 2 = RFQ Recipient	Mandatory

3.1.1.4 RFQ LP Matching Status (37)

Client ◀OEG

Available for: FUND

Message Usage:

The **RFQLPMatchingStatus** (37) message is sent by the trading engine to inform Liquidity Providers about their potential matching situation at the time the message is sent.

The field *Potential Matching Quantity* will contain the potential matching quantity of the concerned LP's answer (identified by the *QuoteReqID*).

Field	Short Description	Format	Len	Values	Presence
Message Sequence Number	Indicates the Message Sequence Number per OE Session. (for messages sent by the Exchange)	Sequence	4	From 0 to 2 ³² -2	Mandatory
Firm ID	Identifier of the member firm that sends the message.	Alphanumerical ID	8	(See field description)	Mandatory
Book IN Time	Matching Engine IN time (in ns), time at which the corresponding inbound message entered the Matching Engine. (Time in number of nanoseconds since 01/01/1970 UTC)	Epoch Time in Nanoseconds	8	From 0 to 2 ⁶⁴ -2	Mandatory
Book OUT Time	Matching Engine OUT time (in ns), when message leaves the Matching Engine (Time in number of nanoseconds since 01/01/1970 UTC).	Epoch Time in Nanoseconds	8	From 0 to 2 ⁶⁴ -2	Conditional
OEG IN From ME	Gateway IN time from ME (in ns), measured when outbound message enters the gateway (Time in number of nanoseconds since 01/01/1970 UTC).	Epoch Time in Nanoseconds	8	From 0 to 2 ⁶⁴ -2	Conditional
OEG OUT To Member	Order Entry Gateway OUT time to member (in ns), measured when outbound message leaves the gateway (Time in number of nanoseconds since 01/01/1970 UTC).	Epoch Time in Nanoseconds	8	From 0 to 2 ⁶⁴ -2	Conditional
QuoteReqID	Numerical RFQ identifier assigned by the matching engine, unique per instrument and EMM.	Numerical ID	8	From 0 to 2 ⁶⁴ -2	Mandatory
Potential Matching Quantity	The potential matching quantity indicates the maximum volume that would be matched in case of an RFQ validation.	Quantity	8	From 0 to 2 ⁶⁴ -2	Mandatory
Symbol Index	Exchange identification code of the instrument.	Numerical ID	4	From 0 to 2 ³² -2	Mandatory

Field	Short Description	Format	Len	Values	Presence
EMM	Defines the Exchange Market Mechanism applied on each platform.	Enumerated	1	(See field description)	Mandatory
Order Side	Indicates the side of the order	Enumerated	1	1 = Buy 2 = Sell	Mandatory

3.1.1.5 RFQ Audit (72)

Client ◀OEG

Available for: FUND

Message Usage:

The **RFQAudit** (72) message is sent after a confirmation leading to a trade by the trading engine in order to give to the RFQ issuer the list of all answers received for the given RFQ, whatever their status after the confirmation.

Field	Short Description	Format	Len	Values	Presence
Message Sequence Number	Indicates the Message Sequence Number per OE Session. (for messages sent by the Exchange)	Sequence	4	From 0 to 2 ³² -2	Mandatory
Firm ID	Identifier of the member firm that sends the message.	Alphanumerical ID	8	(See field description)	Mandatory
Book IN Time	Matching Engine IN time (in ns), time at which the corresponding inbound message entered the Matching Engine. (Time in number of nanoseconds since 01/01/1970 UTC)	Epoch Time in Nanoseconds	8	From 0 to 2 ⁶⁴ -2	Mandatory
Book OUT Time	Matching Engine OUT time (in ns), when message leaves the Matching Engine (Time in number of nanoseconds since 01/01/1970 UTC).	Epoch Time in Nanoseconds	8	From 0 to 2 ⁶⁴ -2	Conditional
OEG IN From ME	Gateway IN time from ME (in ns), measured when outbound message enters the gateway (Time in number of nanoseconds since 01/01/1970 UTC).	Epoch Time in Nanoseconds	8	From 0 to 2 ⁶⁴ -2	Conditional
OEG OUT To Member	Order Entry Gateway OUT time to member (in ns), measured when outbound message leaves the gateway (Time in number of nanoseconds since 01/01/1970 UTC).	Epoch Time in Nanoseconds	8	From 0 to 2 ⁶⁴ -2	Conditional
QuoteReqID	Numerical RFQ identifier assigned by the matching engine, unique per instrument and EMM.	Numerical ID	8	From 0 to 2 ⁶⁴ -2	Mandatory
Symbol Index	Exchange identification code of the instrument.	Numerical ID	4	From 0 to 2 ³² -2	Mandatory
EMM	Defines the Exchange Market Mechanism applied on each platform.	Enumerated	1	(See field description)	Mandatory
RFQ Counterparts	Number of Orders (COB and LP) answering the RFQ	Int	2	Minimum 1, maximum 50	Mandatory
Order Origin	Indicates the origin of the order	Enumerated	1	(See field description)	Optional

Field	Short Description	Format	Len	Values	Presence	
Order Price	Instrument price per quantity unit.	Price	8	From -2^{63} to $2^{63}-1$	Optional	
Last Traded Quantity	The Last Traded Quantity indicates the quantity of last fill on an instrument (to be calculated with the Quantity Decimals).	Quantity	8	From 0 to $2^{64}-2$	Optional	
Dark Execution Instruction	Field used as instruction for dark order handling. Values specified, in the list of possible values, indicate the bit positions that should be used to set zero (0) or one (1) values. A single field contains multiple values provided in different positions.	Bitmap	1	(See field description)	Optional	102
Minimum Order Quantity	Minimum quantity to be executed upon order entry (else the order is rejected), (To be calculated with Quantity Decimals).	Quantity	8	From 0 to $2^{64}-1$	Optional	116

3.1.2 FIX

3.1.2.1 QuoteRequest (R)

Client ► OEG

The **QuoteRequest** (R) message is used by the clients to indicate their intention in a specified instrument.

Fields *Order Side* and *End Client* are optional as the client may or may not specify those parameters depending on the nature of the request.

Tag	Field	Short Description	Format	Len	Values	Presence
	Message Header					Mandatory
60	TransactTime	Indicates the time of message transmission (Format: YYYYMMDD-HH:MM:SS.ssssssss).	UTCTimestamp	27	Valid values: YYYY = 0000-9999, MM = 01-12, DD = 01-31, HH = 00-23, MM = 00-59, SS = 00-59, ssssssss = 00000000-99999999 (nanoseconds)	Mandatory
11	ClOrdID	An identifier of an Order assigned by the Client when submitting an order to the Exchange.	String	20	From $-2^{63}+1$ to $2^{63}-1$	Mandatory
48	SecurityID	Exchange identification code of the instrument, represented by SecurityID. This identifier is unique per triplet: MIC, ISIN and currency. The correspondence between the SecurityID and the instrument characteristics is provided in the standing data messages and associated files.	String	10	From 0 to $2^{32}-2$	Mandatory
22	SecurityIDSource	Gives the type of SecurityID.	String	1	8 = Symbol Index	Mandatory
20020	EMM	Defines the Exchange Market Mechanism applied on each platform.	Int	2	(See field description)	Mandatory
54	Side	Indicates the side of the order.	Char	1	1 = Buy 2 = Sell	Optional
38	OrderQty	Total order quantity, per quantity unit (to be calculated with Quantity Decimals).	Qty	20	From 0 to $2^{64}-2$	Mandatory

Tag	Field	Short Description	Format	Len	Values	Presence
20052	DarkExecutionInstruction	Field used as instruction for dark order handling. This field can contain up to 8 values, space delimited, provided in different positions.	MultipleCharValue	9	0 = Lis Indicator 1 = Deferred Trade Indicator 2 = Lis/Lit Interaction 4 = Minimum Quantity Type	Mandatory
110	MinQty	Minimum quantity to be executed upon order entry (else the order is rejected).	Qty	20	Value '0' by default and depending to a minimum value for the given instrument and/or market type	Optional
453	NoPartyIDs	Number of PartyID entries.	NumInGroup	1	From 1 to 2	Mandatory
448	PartyID	Party identifier/code. See PartyIDSource (447) and PartyRole (452).	String	11	Alphanumeric	Mandatory
447	PartyIDSource	Source of PartyID value.	Char	1	D = Proprietary / Custom Code P = Short code identifier	Mandatory
452	PartyRole	Identifies the type or role of the PartyID (448) specified.	Int	3	1 = Executing Firm 3 = Client ID 12 = Executing Trader 17 = Contra Firm	Mandatory
2376	PartyRoleQualifier	Used to further qualify the value of PartyRole(452).	Int	2	22 = Algorithm 23 = Firm or legal entity 24 = Natural person	Mandatory
6399	AccountCode	Indicates the account type for which the order is entered. For example, an order can be entered for a client account, a house account or a liquidity provider account.	Int	1	(See field description)	Mandatory
	Message Trailer					Mandatory

3.1.2.2 RFQ Notification (U35)

Client ◀OEG

The **RFQNotification** (U35) message is sent by the trading engine to inform Liquidity Providers about the new RFQ characteristics previously received from an RFQ issuer (Client that sent the RFQ) through the **Quote Request** (10) message.

This message is sent to all Liquidity Providers registered for the dedicated instrument.

Tag	Field	Short Description	Format	Len	Values	Presence
	Message Header					Mandatory
2100 2	BookINTime	Matching Engine IN time (in ns), time at which the corresponding inbound message entered the Matching Engine (Format: YYYYMMDD-HH:MM:SS.ssssssss).	UTCTimestamp	27	Valid values: YYYY = 0000-9999, MM = 01-12, DD = 01-31, HH = 00-23, MM = 00-59, SS = 00-59, ssssssss = 000000000-999999999 (nanoseconds)	Mandatory
2100 3	BookOUTTime	Matching Engine OUT time (in ns), when message leaves the Matching Engine (Format: YYYYMMDD-HH:MM:SS.ssssssss).	UTCTimestamp	27	Valid values: YYYY = 0000-9999, MM = 01-12, DD = 01-31, HH = 00-23, MM = 00-59, SS = 00-59, ssssssss = 000000000-999999999 (nanoseconds)	Conditional
7765	OEGINFromME	Gateway IN time from ME (in ns), measured when outbound message enters the gateway (Format: YYYYMMDD-HH:MM:SS.ssssssss).	UTCTimestamp	27	Valid values: YYYY = 0000-9999, MM = 01-12, DD = 01-31, HH = 00-23, MM = 00-59, SS = 00-59, ssssssss = 000000000-999999999 (nanoseconds)	Conditional
7764	OEGOUTToME	Gateway OUT time to ME (in ns), measured when inbound message leaves the gateway (Format: YYYYMMDD-HH:MM:SS.ssssssss).	UTCTimestamp	27	Valid values: YYYY = 0000-9999, MM = 01-12, DD = 01-31, HH = 00-23, MM = 00-59, SS = 00-59, ssssssss = 000000000-999999999 (nanoseconds)	Mandatory
131	QuoteReqID	Numerical RFQ identifier assigned by the matching engine, unique per instrument and EMM.	String	20	From 0 to 2 ⁶⁴ -2	Mandatory

Tag	Field	Short Description	Format	Len	Values	Presence
21035	RFQUpdateType	Indicates the current status of the RFQ.	Char	1	1 = New 2 = Cancelled by the RFQ issuer 3 = Expired 4 = Partially or Fully Matched	Mandatory
48	SecurityID	Exchange identification code of the instrument, represented by SecurityID. This identifier is unique per triplet: MIC, ISIN and currency. The correspondence between the SecurityID and the instrument characteristics is provided in the standing data messages and associated files.	String	10	From 0 to 2 ³² -2	Mandatory
22	SecurityIDSource	Gives the type of SecurityID.	String	1	8 = Symbol Index	Mandatory
20020	EMM	Defines the Exchange Market Mechanism applied on each platform.	Int	2	(See field description)	Mandatory
38	OrderQty	Total order quantity, per quantity unit (to be calculated with Quantity Decimals).	Qty	20	From 0 to 2 ⁶⁴ -2	Mandatory
54	Side	Indicates the side of the order.	Char	1	1 = Buy 2 = Sell	Optional
20052	DarkExecutionInstruction	Field used as instruction for dark order handling. This field can contain up to 8 values, space delimited, provided in different positions.	MultipleCharValue	9	0 = Lis Indicator 1 = Deferred Trade Indicator 2 = Lis/Lit Interaction 3 = Minimum Quantity Type	Mandatory
110	MinQty	Minimum quantity to be executed upon order entry (else the order is rejected).	Qty	20	Value '0' by default and depending to a minimum value for the given instrument and/or market type	Optional
21041	Order Category	Field used as instruction for order handling. When not provided or provided at the Null Value, it is assumed to be set at value 1 "Lit Order".	Char	1	(See field description)	Conditional

Tag	Field	Short Description	Format	Len	Values	Presence
6399	AccountCode	Indicates the account type for which the order is entered. For example, an order can be entered for a client account, a house account or a liquidity provider account.	Int	1	(See field description)	Mandatory
	Message Trailer					Mandatory

3.1.2.3 RFQMatchingStatus (U36)

Client ◀OEG

The **RFQMatchingStatus** (U36) message is sent by the trading engine to inform the RFQ issuer about the potential matching situation at the time the message is sent.

The Field *Potential Matching Price* will contain the matching price related to the *Potential Matching Quantity*.

Tag	Field	Short Description	Format	Len	Values	Presence
	Message Header					Mandatory
2100 2	BookINTime	Matching Engine IN time (in ns), time at which the corresponding inbound message entered the Matching Engine (Format: YYYYMMDD-HH:MM:SS.ssssssss).	UTCTimestamp	27	Valid values: YYYY = 0000-9999, MM = 01-12, DD = 01-31, HH = 00-23, MM = 00-59, SS = 00-59, ssssssss = 000000000-999999999 (nanoseconds)	Mandatory
2100 3	BookOUTTime	Matching Engine OUT time (in ns), when message leaves the Matching Engine (Format: YYYYMMDD-HH:MM:SS.ssssssss).	UTCTimestamp	27	Valid values: YYYY = 0000-9999, MM = 01-12, DD = 01-31, HH = 00-23, MM = 00-59, SS = 00-59, ssssssss = 000000000-999999999 (nanoseconds)	Conditional
7765	OEGINFromME	Gateway IN time from ME (in ns), measured when outbound message enters the gateway (Format: YYYYMMDD-HH:MM:SS.ssssssss).	UTCTimestamp	27	Valid values: YYYY = 0000-9999, MM = 01-12, DD = 01-31, HH = 00-23, MM = 00-59, SS = 00-59, ssssssss = 000000000-999999999 (nanoseconds)	Conditional
7764	OEGOUTToME	Gateway OUT time to ME (in ns), measured when inbound message leaves the gateway (Format: YYYYMMDD-HH:MM:SS.ssssssss).	UTCTimestamp	27	Valid values: YYYY = 0000-9999, MM = 01-12, DD = 01-31, HH = 00-23, MM = 00-59, SS = 00-59, ssssssss = 000000000-999999999 (nanoseconds)	Mandatory

Tag	Field	Short Description	Format	Len	Values	Presence
48	SecurityID	Exchange identification code of the instrument, represented by SecurityID. This identifier is unique per triplet: MIC, ISIN and currency. The correspondence between the SecurityID and the instrument characteristics is provided in the standing data messages and associated files.	String	10	From 0 to $2^{32}-2$	Mandatory
22	SecurityIDSource	Gives the type of SecurityID.	String	1	8 = Symbol Index	Mandatory
20020	EMM	Defines the Exchange Market Mechanism applied on each platform.	Int	2	(See field description)	Mandatory
131	QuoteReqID	Numerical RFQ identifier assigned by the matching engine, unique per instrument and EMM.	String	20	From 0 to $2^{64}-2$	Mandatory
21030	PotentialMatchingPrice	The PotentialMatchingPrice indicates to the RFQ issuer the matching price (to be calculated with Price/Index Level Decimals) for the PotentialMatchingQuantity.	Price	20	From $-2^{63}+1$ to $2^{63}-1$	Conditional
21031	PotentialMatchingQuantity	The PotentialMatchingQuantity indicates the maximum volume that would be matched in case of an RFQ validation (to be calculated with Quantity Decimals).	Qty	20	From 0 to $2^{64}-2$	Mandatory
54	Side	Indicates the side of the order.	Char	1	1 = Buy 2 = Sell	Mandatory
21034	NumberOfLPs	Indicates the number of LP answers to the RFQ (whatever they can be executed or not)	Int	2	From 0 to 2^8-2	Conditional
	Message Trailer					Mandatory

3.1.2.4 RFQLPMatchingStatus (U37)

Client ◀OEG

Available for: FUND

Message Usage:

The **RFQLPMatchingStatus** (U37) message is sent by the trading engine to inform Liquidity Providers about their potential matching situation at the time the message is sent.

The field *Potential Matching Quantity* will contain the potential matching quantity of the concerned LP's answer (identified by the *QuoteReqID*).

Tag	Field	Short Description	Format	Len	Values	Presence
	Message Header					Mandatory
2100 2	BookINTime	Matching Engine IN time (in ns), time at which the corresponding inbound message entered the Matching Engine (Format: YYYYMMDD-HH:MM:SS.ssssssss).	UTCTimestamp	27	Valid values: YYYY = 0000-9999, MM = 01-12, DD = 01-31, HH = 00-23, MM = 00-59, SS = 00-59, ssssssss = 00000000-99999999 (nanoseconds)	Mandatory
2100 3	BookOUTTime	Matching Engine OUT time (in ns), when message leaves the Matching Engine (Format: YYYYMMDD-HH:MM:SS.ssssssss).	UTCTimestamp	27	Valid values: YYYY = 0000-9999, MM = 01-12, DD = 01-31, HH = 00-23, MM = 00-59, SS = 00-59, ssssssss = 00000000-99999999 (nanoseconds)	Conditional
7765	OEGINFromME	Gateway IN time from ME (in ns), measured when outbound message enters the gateway (Format: YYYYMMDD-HH:MM:SS.ssssssss).	UTCTimestamp	27	Valid values: YYYY = 0000-9999, MM = 01-12, DD = 01-31, HH = 00-23, MM = 00-59, SS = 00-59, ssssssss = 00000000-99999999 (nanoseconds)	Conditional
7764	OEGOUTToME	Gateway OUT time to ME (in ns), measured when inbound message leaves the gateway (Format: YYYYMMDD-HH:MM:SS.ssssssss).	UTCTimestamp	27	Valid values: YYYY = 0000-9999, MM = 01-12, DD = 01-31, HH = 00-23, MM = 00-59, SS = 00-59, ssssssss = 00000000-99999999 (nanoseconds)	Mandatory

Tag	Field	Short Description	Format	Len	Values	Presence
48	SecurityID	Exchange identification code of the instrument, represented by SecurityID. This identifier is unique per triplet: MIC, ISIN and currency. The correspondence between the SecurityID and the instrument characteristics is provided in the standing data messages and associated files.	String	10	From 0 to 2 ³² -2	Mandatory
22	SecurityIDSource	Gives the type of SecurityID.	String	1	8 = Symbol Index	Mandatory
2020	EMM	Defines the Exchange Market Mechanism applied on each platform.	Int	2	(See field description)	Mandatory
131	QuoteReqID	Numerical RFQ identifier assigned by the matching engine, unique per instrument and EMM.	String	20	From 0 to 2 ⁶⁴ -2	Mandatory
21031	PotentialMatchingQuantity	The PotentialMatchingQuantity indicates the maximum volume that would be matched in case of an RFQ validation (to be calculated with Quantity Decimals).	Qty	20	From 0 to 2 ⁶⁴ -2	Mandatory
37	OrderID	Numerical order identifier assigned by the matching engine, unique per instrument and EMM.	String	20	From 0 to 2 ⁶⁴ -1	Conditional
	Message Trailer					Mandatory

3.1.2.5 RFQ Audit (U72)

Client ◀OEG

Available for: FUND

Message Usage:

The **RFQAudit** (U72) message is sent after a confirmation leading to a trade by the trading engine in order to provide the RFQ issuer with a list of all answers received for the given RFQ, whatever their status after the confirmation.

Field	Short Description	Format	Len	Values	Presence
MsgSeqNum	The MsgSeqNum is mandatory for all inbound messages.	SeqNum	10	From 1 to 2 ³² -2	Mandatory
SenderCompID	Identifier of the member firm that sends the message.	String	8	Inbound: Firm ID Outbound: Exchange ID	Mandatory
BookINTime	Matching Engine IN time (in ns), time at which the corresponding inbound message entered the Matching Engine (Format: YYYYMMDD-HH:MM:SS.ssssssss).	UTCTimesta mp	27	Valid values: YYYY = 0000-9999, MM = 01-12, DD = 01-31, HH = 00-23, MM = 00-59, SS = 00-59, ssssssss = 000000000-999999999 (nanoseconds)	Mandatory
BookOUTTime	Matching Engine OUT time (in ns), when message leaves the Matching Engine (Format: YYYYMMDD-HH:MM:SS.ssssssss).	UTCTimesta mp	27	Valid values: YYYY = 0000-9999, MM = 01-12, DD = 01-31, HH = 00-23, MM = 00-59, SS = 00-59, ssssssss = 000000000-999999999 (nanoseconds)	Conditional
OEGINFromME	Gateway IN time from ME (in ns), measured when outbound message enters the gateway (Format: YYYYMMDD-HH:MM:SS.ssssssss).	UTCTimesta mp	27	Valid values: YYYY = 0000-9999, MM = 01-12, DD = 01-31, HH = 00-23, MM = 00-59, SS = 00-59, ssssssss = 000000000-999999999 (nanoseconds)	Conditional
OEGOUTToME	Gateway OUT time to ME (in ns), measured when inbound message leaves the gateway (Format: YYYYMMDD-HH:MM:SS.ssssssss).	UTCTimesta mp	27	Valid values: YYYY = 0000-9999, MM = 01-12, DD = 01-31, HH = 00-23, MM = 00-59, SS = 00-59, ssssssss = 000000000-999999999 (nanoseconds)	Mandatory
QuoteReqID	Numerical RFQ identifier assigned by the matching engine, unique per instrument and EMM.	String	20	From 0 to 2 ⁶⁴ -2	Mandatory

Field	Short Description	Format	Len	Values	Presence
SecurityID	Exchange identification code of the instrument, represented by SecurityID. This identifier is unique per triplet: MIC, ISIN and currency. The correspondence between the SecurityID and the instrument characteristics is provided in the standing data messages and associated files.	String	10	From 0 to $2^{32}-2$	Mandatory
EMM	Defines the Exchange Market Mechanism applied on each platform.	Int	2	(See field description)	Mandatory
NoAnswersOrderID	Number of Orders (COB and LP) answering the RFQ	Int	2	Minimum 1, maximum 50	Mandatory
OrderID	Numerical order identifier assigned by the matching engine, unique per instrument and EMM.	String	20	From 0 to $2^{64}-2$	Mandatory
Order Book	Specifies if the order was inserted in the order book or if it was dedicated to the RFQ (LP's answer)	Int	1	1 = COB 2 = LP's answer	Mandatory
Price	Instrument price per quantity unit (to be calculated with Price/Index Level Decimals).	Price	20	From $-2^{63}+1$ to $2^{63}-1$	Mandatory
LastQty	The LastQty indicates the quantity of the last fill on an instrument (to be calculated with Quantity Decimals).	Qty	20	From 0 to $2^{64}-1$	Mandatory
LeavesQty	Indicates the remaining quantity of an order, i.e. the quantity open for further execution (to be calculated with Quantity Decimals).	Qty	20	From -1 to $2^{64}-2$	Mandatory
DarkExecutionInstruction	Field used as instruction for dark order handling. This field can contain up to 8 values, space delimited, provided in different positions.	MultipleChar Value	9	(See field description)	Mandatory
MinQty	Minimum quantity to be executed upon order entry (else the order is rejected).	Qty	20	From 0 to $2^{64}-1$	Mandatory

3.2 PUBLIC MESSAGES

All public messages are described in the OPTIQ MDG CLIENT SPECIFICATIONS document, available in the Connect customer portal.

3.2.1 Order Update (1002)

If the RFQ results in a trade, is cancelled or expires, for each LP having answered, an order update will be sent to the market using: Market Data Action Type = " 7 = RFQ Answer Creation".

3.2.2 Market Update (1001)

An RFQ will be sent to liquidity providers in private messages. Market participants will not be informed of this RFQ.

If the RFQ results in a trade, is cancelled or expires, for each LP having answered, all Lit answers to the RFQ (including cancelled ones) are sent in market data using Market Data Update Type: "83 = New Bid RFQ Answer" and/or "84 = New Offer RFQ Answer".

After the trade, and only in this case, a message is immediately sent using the following Market Data Update types:

- If the trade occurs between an RFQ issuer and an RFQ responder, Market Data Update Type value ('105' RFQ Trade) is disseminated in MDG Full Trade Information message;
- If the trade occurs between an RFQ issuer and a COB order, Market Data Update Type value ('24' Conventional Trade) is disseminated in MDG Full Trade Information message.

A final message is sent to indicate that the RFQ answers are no longer tradable: "86 – Clear RFQ Answers".

A trade occurring between an RFQ issuer and an order from the COB is considered as a conventional trade and in this case:

- BBO is updated
- Stop orders are triggered following a trade occurring between an RFQ issuer and a COB order.

In the case of a pure RFQ trade, RFQ issuer versus RFQ responder (Market Data Update Type value = '105' RFQ Trade):

- BBO is not updated
- Stop orders are not triggered following a trade occurring between an RFQ issuer and an RFQ responder.

3.2.3 Full Trade Information (1004)

The Full Trade message is sent after every trade resulting from an RFQ. It contains trade information, including all MiFID II regulatory fields.

Two types of trade can be disseminated:

- If the trade occurs between an RFQ issuer and an RFQ responder, Trade Type value ('104' RFQ Trade) is disseminated in MDG Full Trade Information message
- If the trade occurs between an RFQ issuer and a COB order, Trade Type value ('1' Conventional Trade) is disseminated in MDG Full Trade Information message.

A trade occurring between an RFQ issuer and an order from the COB is considered as a conventional trade and in this case:

- The Last Trade Price is updated;
- The flag as first trade is potentially set;
- Stop orders are potentially triggered;
- The Dynamic Collar Reference Price is updated;
- The Static Collar Reference Price is updated only in case of the first trade on the COB, not updated otherwise;
- The Closing Price is updated;
- The Official Price is updated;
- MDG statistics are updated.

In the case of a pure RFQ trade, RFQ issuer versus RFQ responder (Trade Type = '104' RFQ Trade):

- The Last Trade Price is not updated;
- The flag as first trade is not set;
- Stop orders are not triggered;
- The Dynamic Collar Reference Price is not updated;
- The Static Collar Reference Price is not updated;
- The Closing Price is not updated;
- The Official Price is not updated;
- The prices in MDG statistics are not updated.

3.2.4 Statistics (1009)

This message provides statistics on prices and volumes on an instrument and is sent each time a statistic value is modified

A trade occurring between an RFQ Issuer and an RFQ Responder will never impact MDG Statistics regarding price by excluding the new Trade Type value ('104' RFQ Trade) from statistics generation.

A trade occurring between an RFQ Issuer and an RFQ Responder DOES NOT impact:

- Daily High
- Daily Low
- Yearly High
- Yearly Low
- Lifetime High
- Lifetime Low
- Variation Last Price
- Last Traded Price
- Percentage Variation Previous Close
- On Book Continuous Cumulative Quantity

A trade occurring between an RFQ Issuer and an RFQ Responder impacts:

- Trade Count,
- Off Book Cumulative Quantity,
- On and Off Book Cumulative Quantity.

A trade occurring between an RFQ responder and an order from the COB is considered as a conventional trade which impacts the following values:

- Daily High
- Daily Low
- Yearly High
- Yearly Low
- Lifetime High
- Lifetime Low
- Variation Last Price
- Trade Count
- Last Traded Price
- Percentage Variation Previous Close
- On Book Continuous Cumulative Quantity
- On and Off Book Cumulative Quantity

Note: Percentage Variation Previous NAV, On Book Auction Cumulative Quantity, and Open Price are not applicable in the RFQ Market Model.

3.3 KINEMATICS

3.3.1 RFQ Rejected

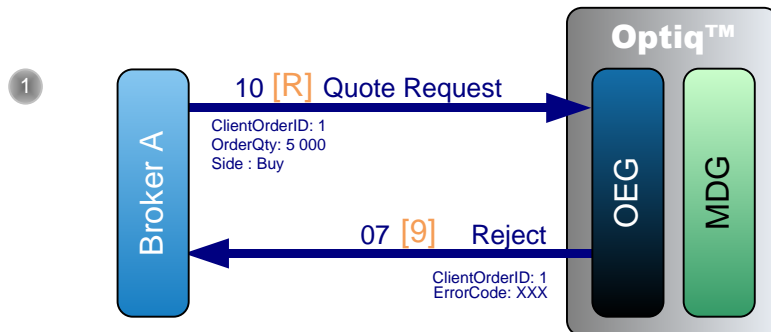

A Broker sends a private **Quote Request** (10) (FIX R) message to broadcast to the LPs concerned a new RFQ order with a quantity of 5,000.

If the request is rejected, the Order Entry Gateway (OEG) sends back a private **Reject** (07) (FIX 9) message with an Error Code. The reason for the rejection can be found using the Error Code within the *Error list document*. No message is sent to the Market.

3.3.2 RFQ Not Confirmed

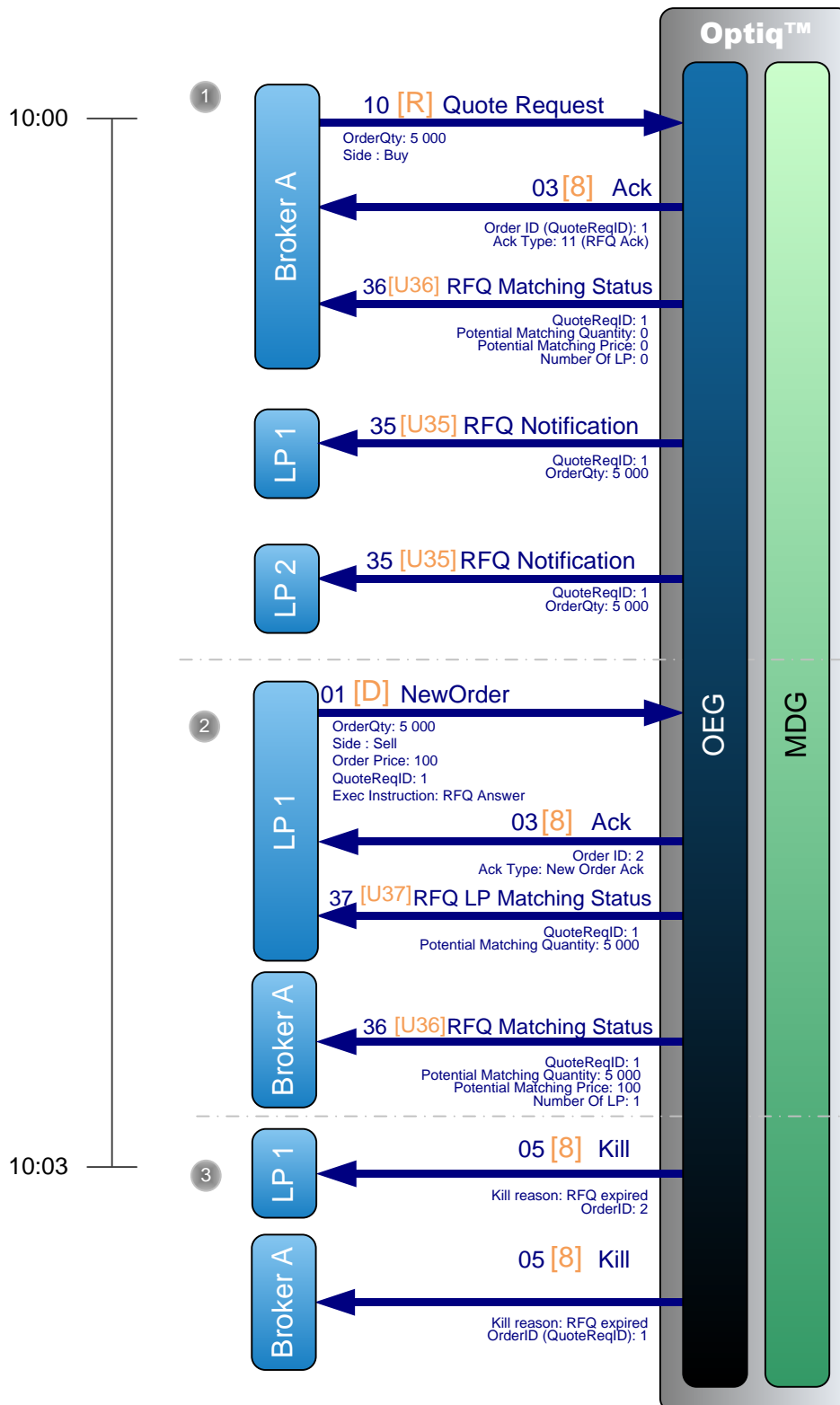

- ① A Broker sends a private **Quote Request** (10) (FIX R) message to broadcast a new RFQ order with a quantity of 5,000. OEG sends back a private **Ack** (03) (FIX 8) message to confirm the successful receipt and technical processing of the RFQ. This Ack message is an "RFQ Ack". As a consequence the OrderID will contain the QuoteReqID.

OEG sends an **RFQ Notification** (35) (FIX U35) message to every Liquidity Provider registered for the instrument concerned.

OEG sends an **RFQ Matching Status** (36) (FIX U36) message to the broker (RFQ issuer) with information about the potential matching situation (potential matching price and potential matching quantity). Potential Matching Price and Quantity are calculated from existing Lit and Dark orders in the Order Book (there is no answer from LPs at this stage).

- ② LP 1 answers the RFQ with a **NewOrder** (01) (FIX D) message with a quantity of 5,000 and a price of 100. This order is identified as an RFQ answer by RFQ Answer set to Yes and it will not be able to match against any other order than the RFQ validation.

OEG sends back a private **Ack** (03) (FIX 8) message to confirm the successful receipt and technical processing of the order.

It is not published through market data channel as per the MiFID II regulation (*Responses to a request for quote may be published when they become executable*).

OEG sends an **RFQ Matching Status** (36) (FIX U36) message to the broker (RFQ issuer) with information about the potential matching situation (*potential matching price and potential matching quantity*).

OEG sends an **RFQ LP Matching Status** (37) (FIX U37) message to the LP with information about the potential matching situation (*potential matching quantity*).

- ③ 180 seconds after the **Quote Request** (10) (R) message has been submitted, Broker A (RFQ issuer) and LP1 receive a **Kill** (05) (8) message that the RFQ has not been confirmed.

3.3.3 RFQ Cancelled

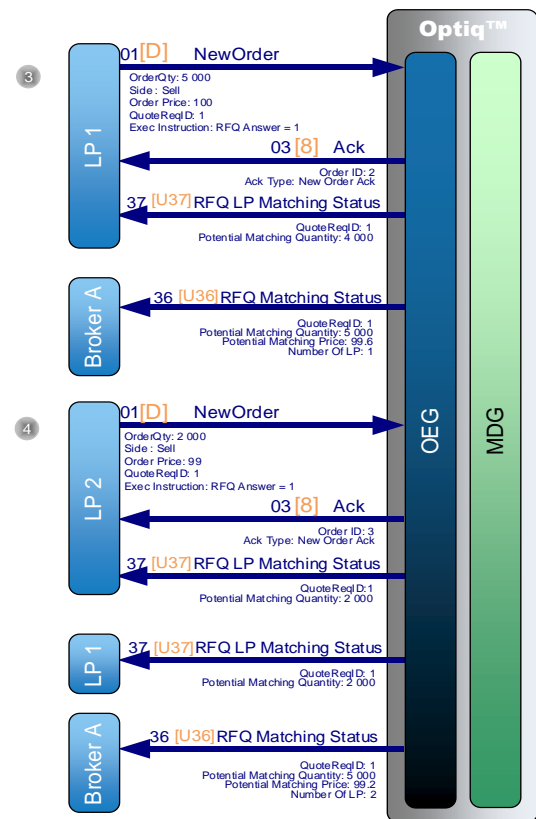
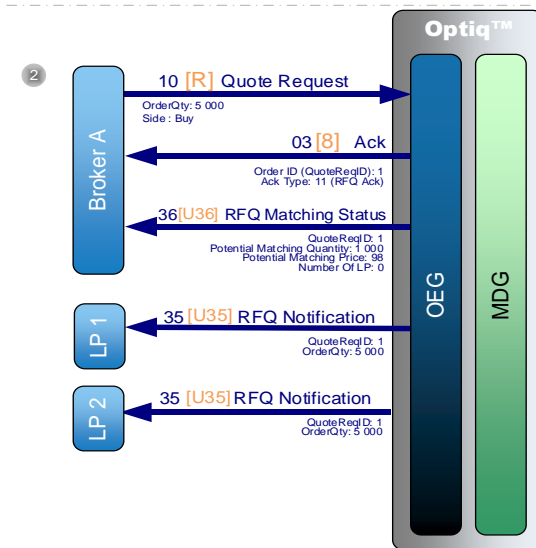
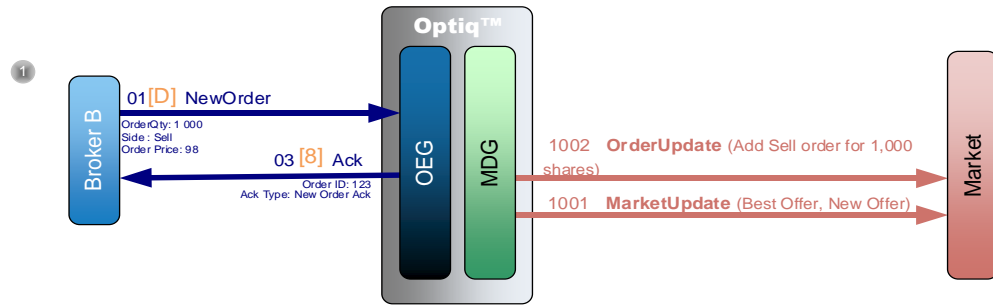

- ① A Broker sends a private **NewOrder** (01) (FIX D) message to enter a new Sell order with a quantity of 1,000. OEG sends back a private **Ack** (03) (FIX 8) message to confirm the successful receipt and technical processing of the order.

The order enters the order book without matching and a public **OrderUpdate** (1002) message is sent to the market to add the order and a **MarketUpdate** (1001) message to update the limits.

- ② A Broker sends a private **Quote Request** (10) (FIX R) message to broadcast a new RFQ order with a quantity of 5,000. OEG sends back a private **Ack** (03) (FIX 8) message to confirm the successful receipt and technical processing of the RFQ. This Ack message is an "RFQ Ack", as a consequence the *Order ID* will contain the QuoteReqID.

OEG sends an **RFQ Notification** (35) (FIX U35) message to every Liquidity Provider registered for the instrument concerned.

OEG sends an **RFQ Matching Status** (36) (FIX U36) message to the broker (RFQ issuer) with information about the potential matching situation (potential matching price and potential matching quantity). Potential Matching Price and Quantity are calculated from existing Lit and Dark orders in the Order Book (there is no answer from LPs at this stage).

- ③ LP 1 answers the RFQ with a **NewOrder** (01) (FIX D) message with a quantity of 5,000 and a price of 100. This order is identified as an RFQ answer by RFQ Answer set to Yes and it will not be able to match against any other order than the RFQ validation.

It is not published through market data channel as per the MiFID II regulation (*Responses to a request for quote may be published when they become executable*). OEG sends back a private **Ack** (03) (FIX 8) message to confirm the successful receipt and technical processing of the order.

OEG sends an **RFQ Matching Status** (36) (FIX U36) message to the broker (RFQ issuer) with information about the potential matching situation (*potential matching price and potential matching quantity*).

OEG sends an **RFQ LP Matching Status** (37) (FIX U37) message to the LP with information about the potential matching situation (*potential matching quantity*).

- ④ LP 2 answers the RFQ with a **NewOrder** (01) (FIX D) message with a quantity of 2,000 and a price of 99. This order is identified as an RFQ answer by RFQ Answer set to Yes and it will not be able to match against any other order than the RFQ validation.

It is not published through market data channel as per the MiFID II regulation (*Responses to a request for quote may be published when they become*

executable). OEG sends back a private **Ack** (03) (FIX 8) message to confirm the successful receipt and technical processing of the order.

OEG sends an **RFQ Matching Status** (36) (FIX U36) message to the broker A (RFQ issuer) with information about the potential matching situation (*potential matching price* and *potential matching quantity*).

OEG sends two **RFQ LP Matching Status** (37) (FIX U37) message to both LPs with information about their own potential matching situation (*potential matching quantity*).

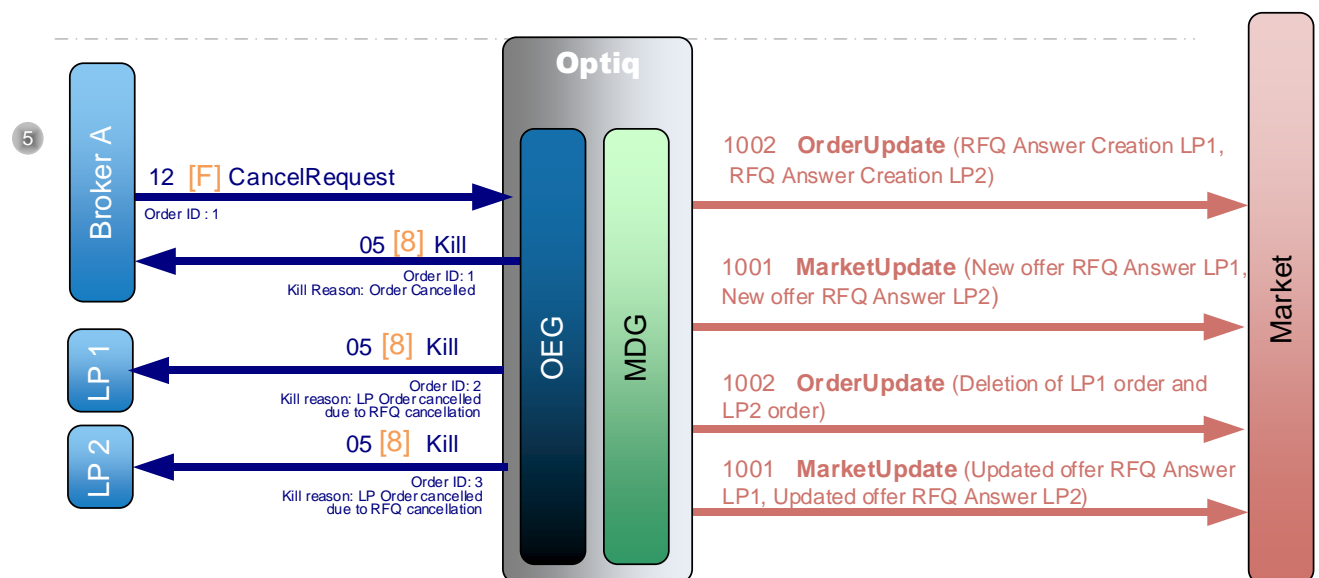

⑤ The same broker sends a private CancelRequest (12) (FIX F) message to cancel the previous entered order.

OEG sends back a private Kill (05) (FIX 8) message to confirm that the order request has been cancelled.

Two **Kill** (05) (FIX 8) messages are sent to LP1 and LP2 with a Kill reason 'LP Order cancelled due to RFQ cancellation'.

The cancellation of the Quote Request will trigger the publication of the LPs' answers to the Market.

A public **OrderUpdate** (1002) message is sent to market data to add the order from LP1 and the one from LP2 with a *Market Data Action Type* '7: RFQ Answer Creation'.

A public **MarketUpdate** (1001) message is sent to the market to update the limits of the RFQ book.

Another public **OrderUpdate** (1002) message is sent to market data to delete both LPs' orders from the RFQ book with *Market Data Action ' 8: RFQ Answer Deletion'*.

Another **MarketUpdate** (1001) message is sent to the market to update the limits of the RFQ.

3.3.4 RFQ Fully Matched

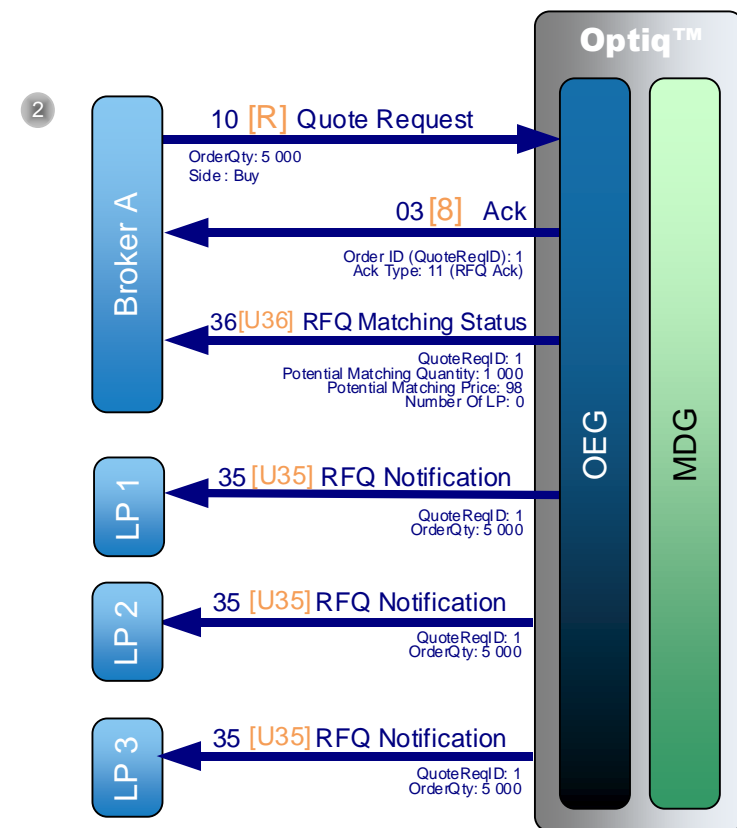
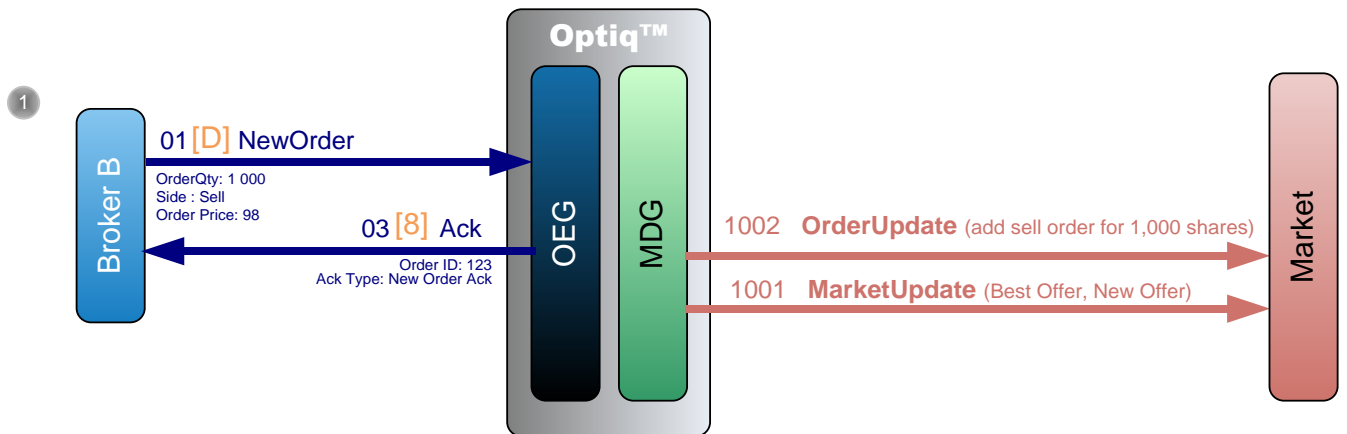

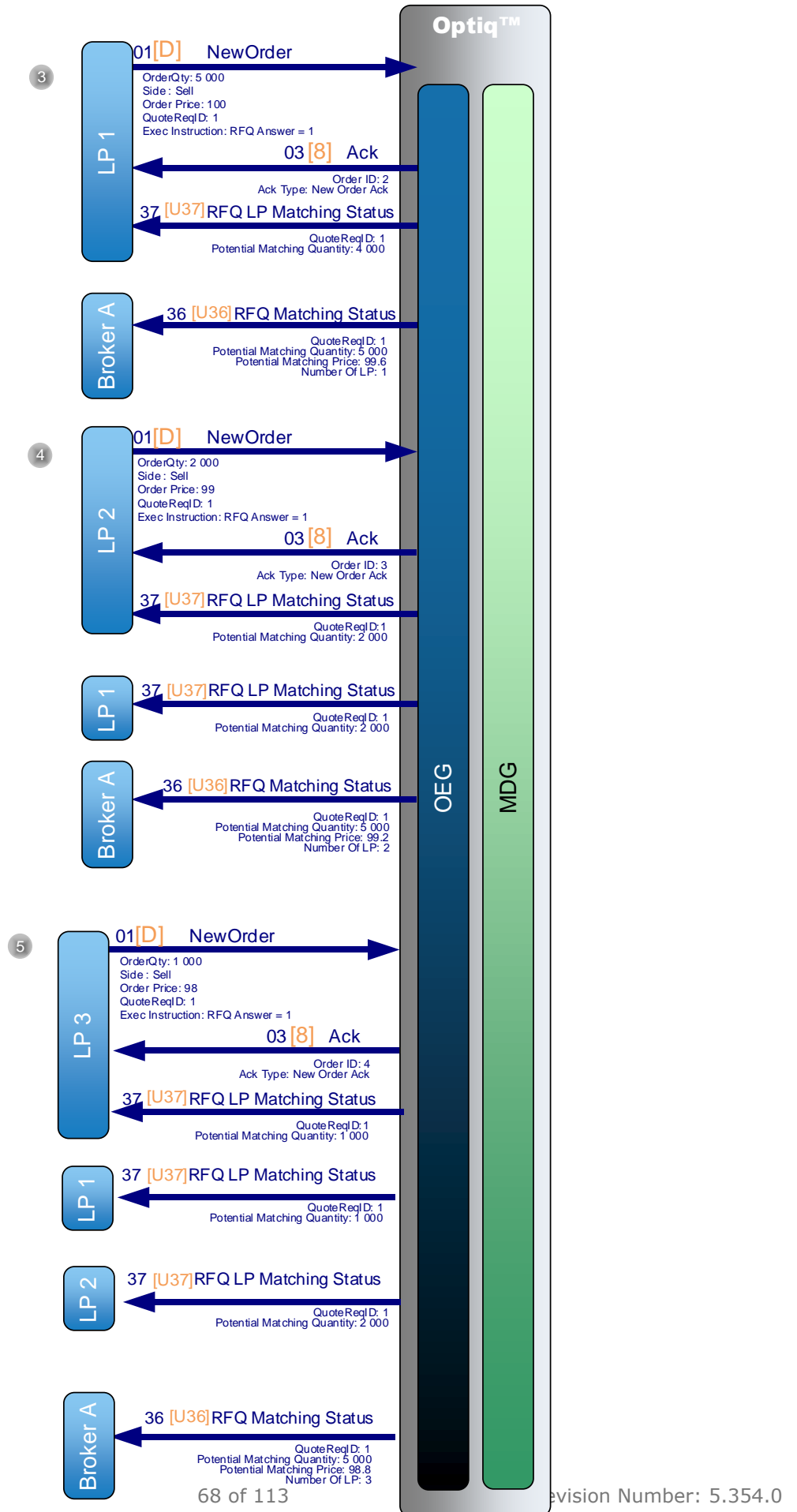

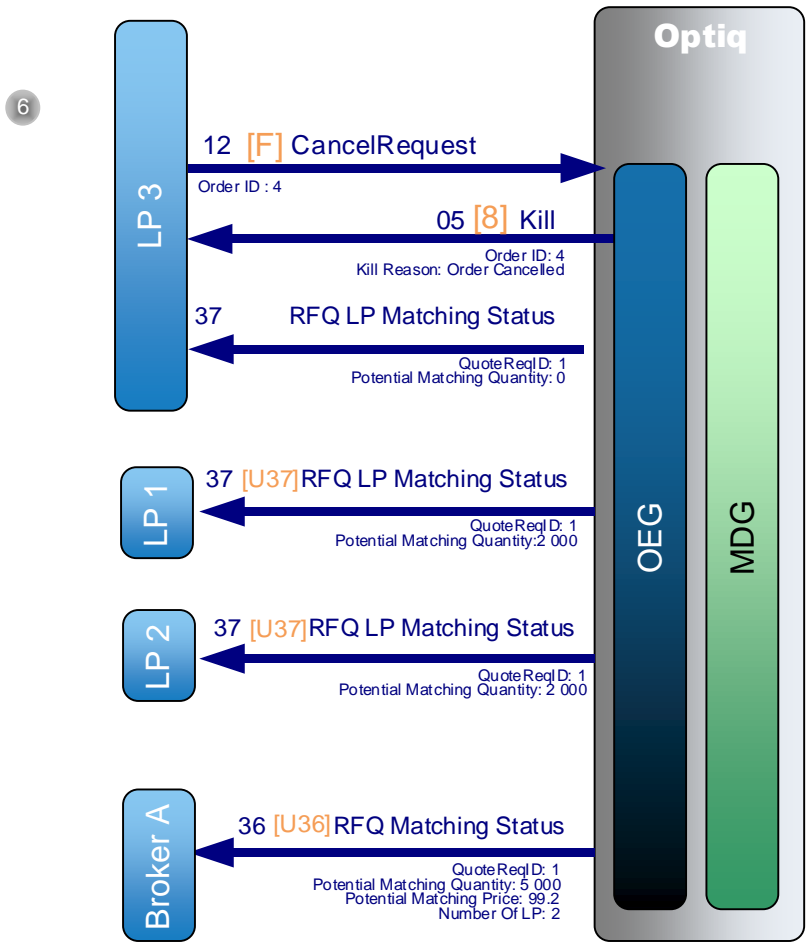

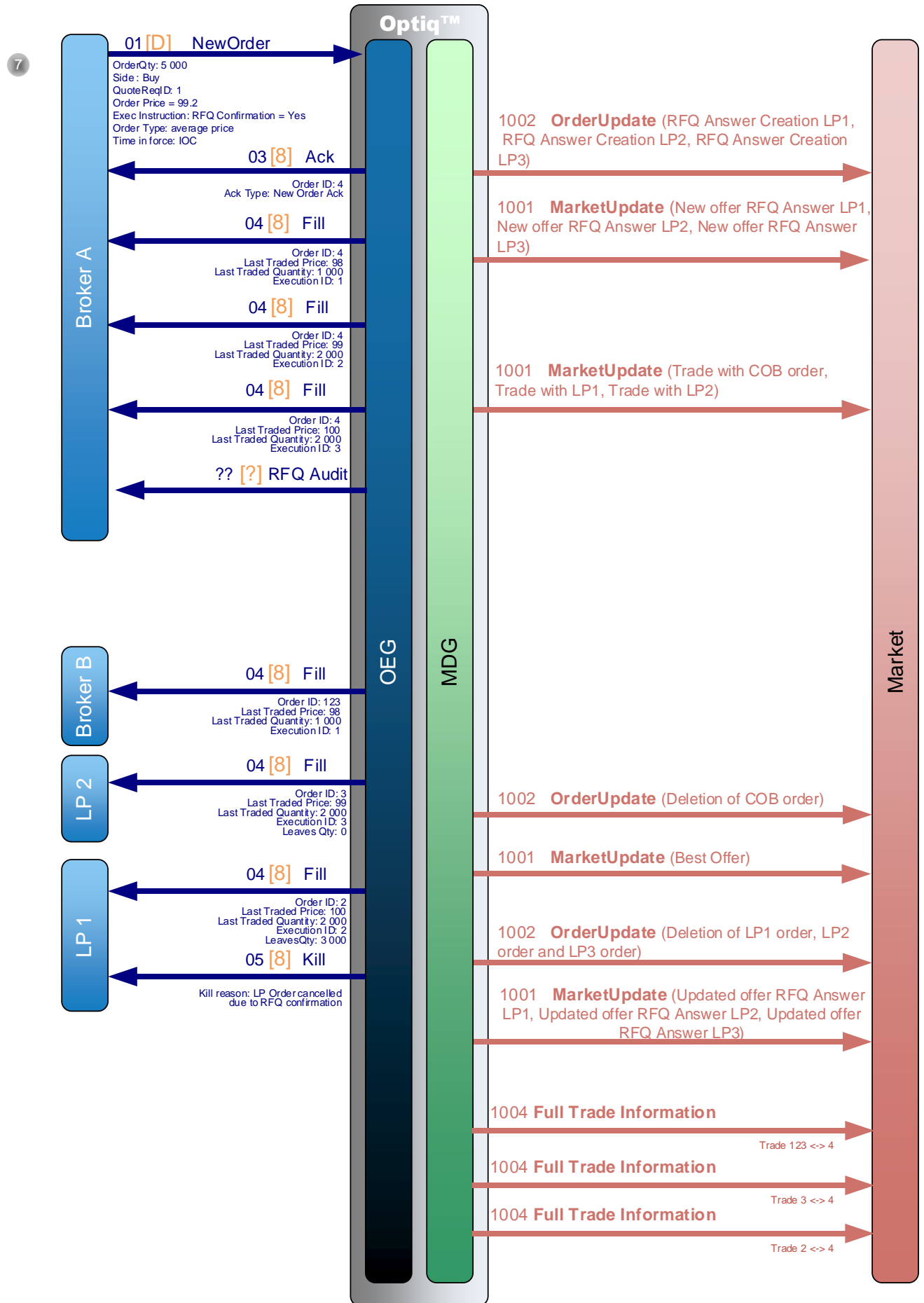

- ① A Broker sends a private **NewOrder** (01) (FIX D) message to enter a new Sell order with a quantity of 1,000. OEG sends back a private **Ack** (03) (FIX 8) message to confirm the successful receipt and technical processing of the order.

The order enters the order book without matching and a public **OrderUpdate** (1002) message is sent to the market to add the order and a **MarketUpdate** (1001) message to update the limits.

- ② A Broker sends a private **Quote Request** (10) (FIX R) message to broadcast a new RFQ with a quantity of 5,000. OEG sends back a private **Ack** (03) (FIX 8) message to confirm the successful receipt and technical processing of the RFQ. This Ack message is an "RFQ Ack", as a consequence the *Order ID* will contain the QuoteReqID.

OEG sends an **RFQ Notification** (35) (FIX U35) message to every Liquidity Provider registered for the instrument concerned.

OEG sends an **RFQ Matching Status** (36) (FIX U36) message to the broker (RFQ issuer) with information about the potential matching situation (potential matching price and potential matching quantity). Potential Matching Price and Quantity are calculated from existing Lit and Dark orders in the Order Book (there is no answer from LP at this stage).

- ③ LP 1 answers the RFQ with a **NewOrder** (01) (FIX D) message with a quantity of 5,000 and a price of 100. This order is identified as an RFQ answer by RFQ Answer set to Yes and it will not be able to match against any other order than the RFQ validation.

It is not published through market data channel as per the MiFID II regulation (*Responses to a request for quote may be published when they become executable*). OEG sends back a private **Ack** (03) (FIX 8) message to confirm the successful receipt and technical processing of the order.

OEG sends an **RFQ Matching Status** (36) (FIX U36) message to the broker (RFQ issuer) with information about the potential matching situation (*potential matching price and potential matching quantity*).

OEG sends an **RFQ LP Matching Status** (37) (FIX U37) message to LPs with information about the potential matching situation (*potential matching quantity*).

- ④ LP 2 answers the RFQ with a **NewOrder** (01) (FIX D) message with a quantity of 2,000 and a price of 99. This order is identified as an RFQ answer by RFQ Answer set to Yes and it will not be able to match against any other order than the RFQ validation.

It is not published through market data channel as per the MiFID II regulation (*Responses to a request for quote may be published when they become*

executable). OEG sends back a private **Ack** (03) (FIX 8) message to confirm the successful receipt and technical processing of the order.

OEG sends an **RFQ Matching Status** (36) (FIX U36) message to the broker A (RFQ issuer) with information about the potential matching situation (*potential matching price* and *potential matching quantity*).

OEG sends two **RFQ LP Matching Status** (37) (FIX U37) message to both LPs with information about their own potential matching situation (*potential matching quantity*).

- ⑤ LP 3 answers the RFQ with a **NewOrder** (01) (FIX D) message with a quantity of 1,000 and a price of 98. This order is identified as an RFQ answer by RFQ Answer set to Yes and it will not be able to match against any other order than the RFQ validation.

It is not published through market data channel as per the MiFID II regulation (*Responses to a request for quote may be published when they become executable*). OEG sends back a private **Ack** (03) (FIX 8) message to confirm the successful receipt and technical processing of the order.

OEG sends an **RFQ Matching Status** (36) (FIX U36) message to the broker A (RFQ issuer) with information about the potential matching situation (*potential matching price* and *potential matching quantity*).

OEG sends two **RFQ LP Matching Status** (37) (FIX U37) message to both LPs with information about their own potential matching situation (*potential matching quantity*).

- ⑥ LP 3 sends a private **Cancel Request** (12) (FIX F) message to cancel the previous entered order.
OEG sends back a private **Kill** (05) (FIX 8) message to confirm that the order request has been cancelled.
OEG sends an **RFQ Matching Status** (36) (FIX U36) message to the broker A (RFQ issuer) with information about the potential matching situation (*potential matching price* and *potential matching quantity*).
OEG sends an **RFQ LP Matching Status** (37) (FIX U37) message to LP1 with information about LP1's own potential matching situation (*potential matching quantity*). LP2 does not receive a message because its potential matching situation is not impacted.
- ⑦ The broker A (RFQ issuer) confirms the RFQ with a **NewOrder** (01) (FIX D) message with a quantity of 5,000 and a price of 99.2.
The new order message Confirmation is sent with an *Order Type 'Average price'* and *Time in Force 'IOC'*.

OEG sends back a private **Ack** (03) (FIX 8) message to confirm the successful receipt and technical processing of the order.

The confirmation of the Quote Request through the New Order will trigger the publication of the LPs' answers to the Market.

A public **OrderUpdate** (1002) message is sent to market data to add the order from LP1 , LP2 and LP3 with a Market Data Action Type ' 7: RFQ Answer Creation'.

A public **MarketUpdate** (1001) message is sent to the market to update the limits of the RFQ book.

The entering order from the RFQ Issuer matches the order in the book (Order ID 123) for a quantity of 1,000 and OEG sends back a private **Fill** (04) (FIX 8) message to the RFQ issuer and to Broker B.

The entering order from the RFQ Issuer matches LP1's order for a quantity of 2,000 and OEG sends back a private **Fill** (04) (FIX 8) message to the RFQ issuer and to LP2.

The entering order from the RFQ Issuer matches LP2's order for a quantity of 2,000 and OEG sends back a private **Fill** (04) (FIX 8) message to the RFQ issuer and to LP1.

An **RFQ Audit** (72) message is sent to the RFQ Issuer with details of orders 2 and 3.

A **Kill** (05) (FIX 8) message is sent to LP1 with a *Kill reason ' LP Order cancelled due to RFQ confirmation'*

because the remaining quantity of LP1 is not null.

A public **MarketUpdate** (1001) message is sent to the market for the trade executed within the COB and for both trade executed with the LPs' responses with *Market Data Update Type ' Trade with Cob order, Trade with LP1 order, Trade with LP2 order'*.

A public **OrderUpdate** message is sent to market data to delete the COB order.

A public **MarketUpdate** (1001) message is sent to the market to update the limits of the COB.

Another public **OrderUpdate** message is sent to market data to delete both LPs' orders from the RFQ book with *Market Data Action '8: RFQ Answer Deletion'*.

Another **MarketUpdate** (1001) message is sent to the market to update the limits of the RFQ.

3.3.5 RFQ Partially Matched

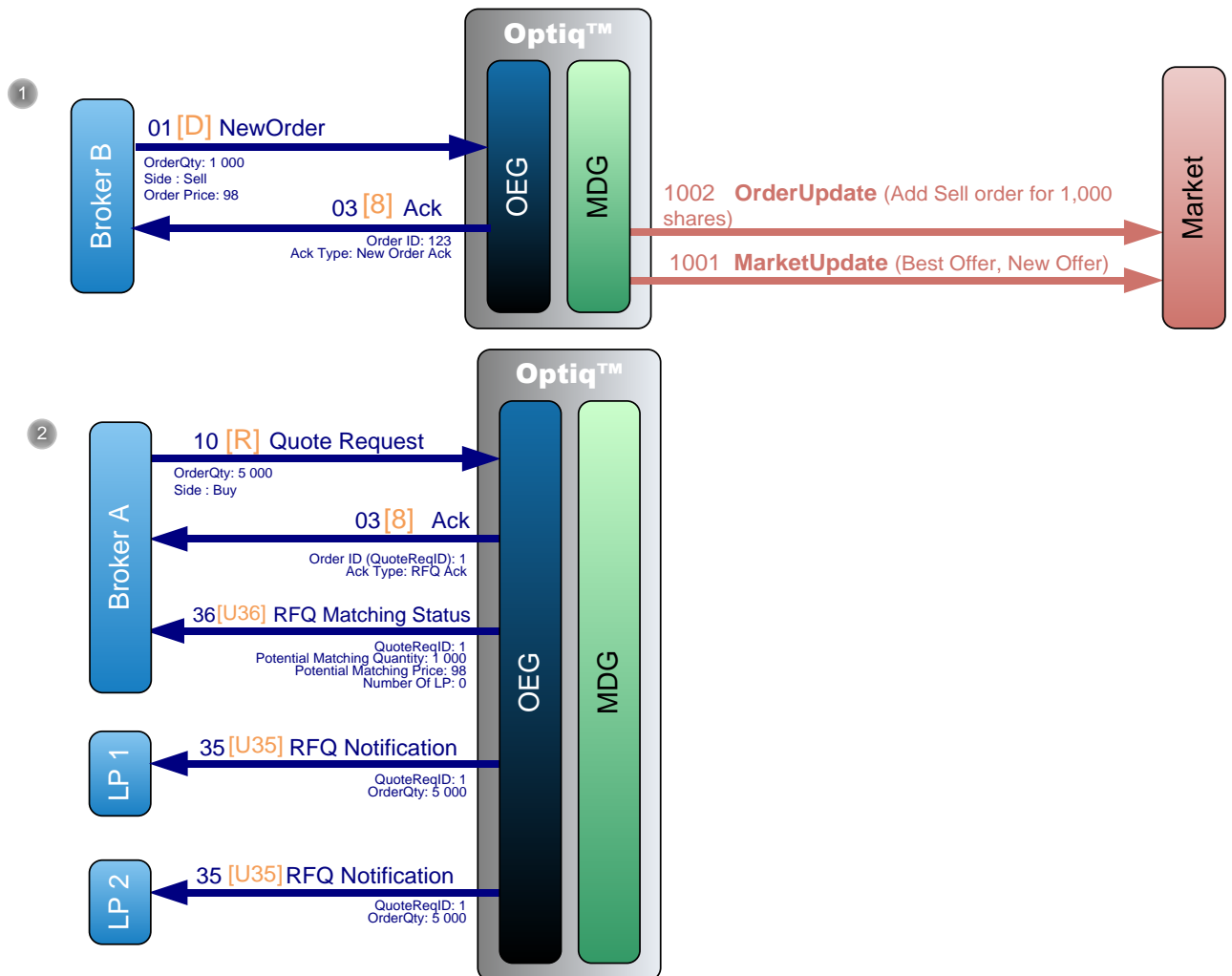

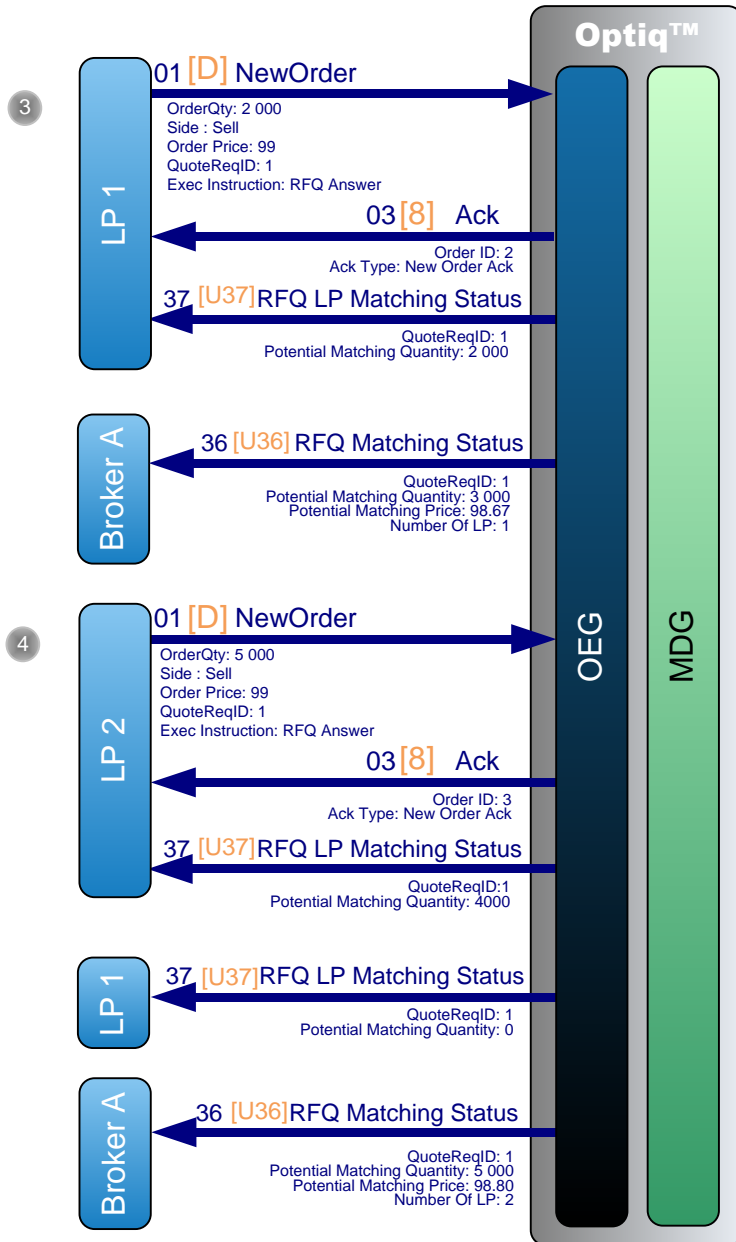

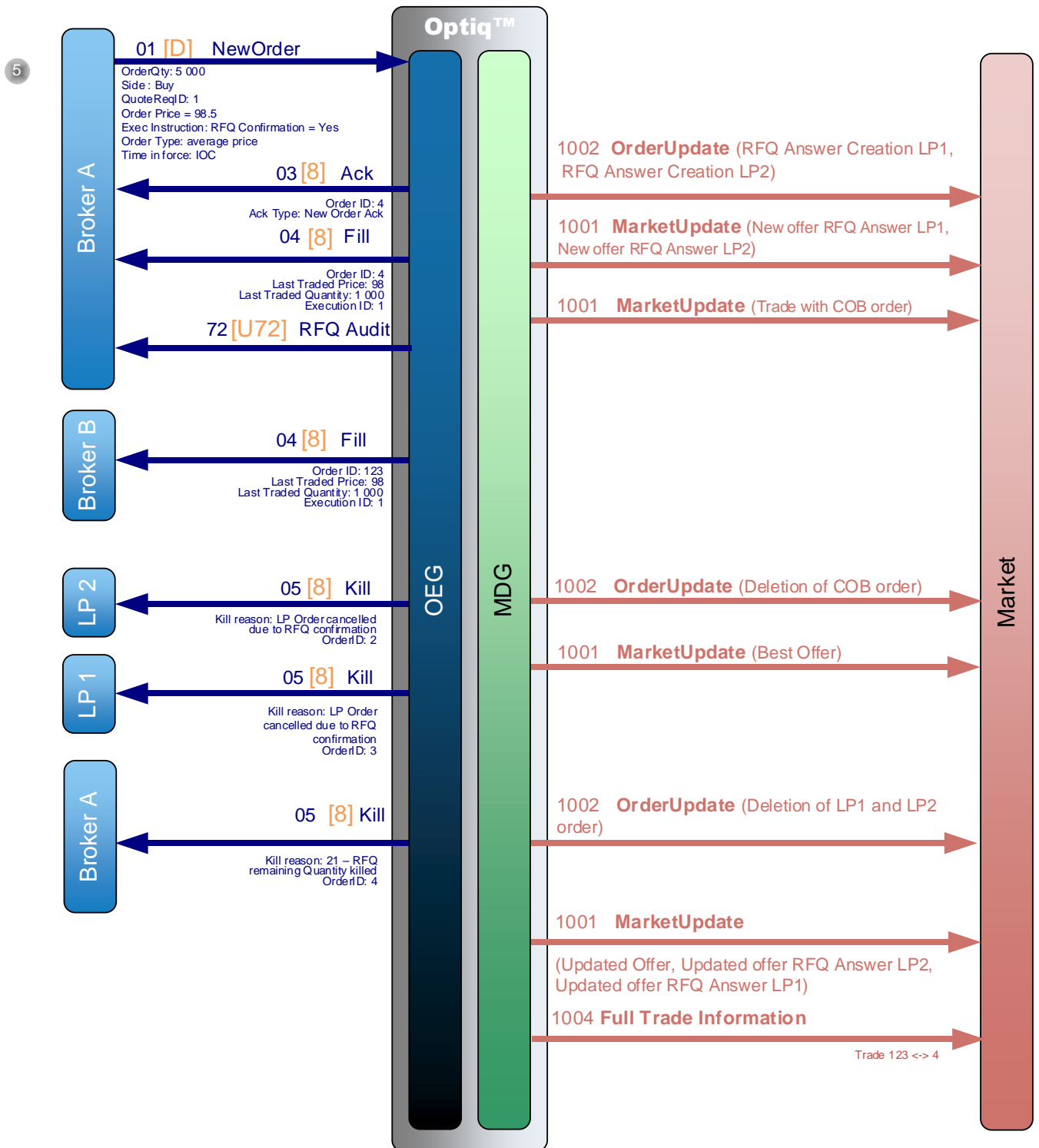

- ① Broker B sends a private **NewOrder** (01) (FIX D) message to enter a new Sell order with a quantity of 1,000. OEG sends back a private **Ack** (03) (FIX 8) message to confirm the successful receipt and technical processing of the order.
The order enters the order book without matching and a public **OrderUpdate** (1002) message is sent to the market to add the order and a **MarketUpdate** (1001) message to update the limits.

- ② Broker A sends a private **Quote Request** (10) (FIX R) message to broadcast a new RFQ order with a quantity of 5,000. OEG sends back a private **Ack** (03) (FIX 8) message to confirm the successful receipt and technical processing of the RFQ. This Ack message is an "RFQ Ack", as a consequence the OrderID will contain the QuoteReqID.
OEG sends an **RFQ Notification** (35) (FIX U35) message to every Liquidity Provider registered for the instrument concerned.
OEG sends one **RFQ Matching Status** (36) (FIX U36) message to the broker (RFQ issuer) with information about the potential matching situation (potential matching price and potential matching quantity). Potential Matching Price and Quantity are calculated from existing Lit and Dark orders in the Order Book (there is no answer from LP at this stage).

- ③ LP 1 answers the RFQ with a **NewOrder** (01) (FIX D) message with a quantity of 2,000 and a price of 99. This order is identified as an RFQ answer by RFQ Answer set to Yes and it will not be able to match against any other order than the RFQ validation.
OEG sends back a private **Ack** (03) (FIX 8) message to confirm the successful receipt and technical processing of the order.
OEG sends an **RFQ Matching Status** (36) (FIX U36) message to the broker (RFQ issuer) with information about the potential matching situation (*potential matching price and potential matching quantity*) on Buy side.
OEG sends an **RFQ LP Matching Status** (37) (FIX U37) message to the LP with information about the potential matching situation (*potential matching quantity*).

- ④ LP 2 answers the RFQ with a **NewOrder** (01) (FIX D) message with a quantity of 5,000 and a price of 100. This order is identified as an RFQ answer by RFQ Answer set to Yes and it will not be able to match against any other order than the RFQ validation.
It is not published through market data channel as per the MiFID II regulation (*Responses to a request for quote may be published when they become executable*). OEG sends back a private **Ack** (03) (FIX 8) message to confirm the successful receipt and technical processing of the order.
OEG sends an **RFQ Matching Status** (36) (FIX U36) message to the broker A (RFQ issuer) with information about the potential matching situation (*potential*

matching price and potential matching quantity) on Sell side with an updated number of LP = 2.

OEG sends an **RFQ LP Matching Status** (37) (FIX U37) message to LP1 & LP2 with information about the potential matching situation (*potential matching quantity*).

- ⑤ The broker A (RFQ issuer) confirms the RFQ with a **NewOrder** (01) (FIX D) message with a quantity of 5,000 and a price of 98.5.

The new order message Confirmation is sent with an *Order Type 'Average price'* and *Time in Force 'IOC'*.

OEG sends back a private **Ack** (03) (FIX 8) message to confirm the successful receipt and technical processing of the order.

The confirmation of the Quote Request through the New Order will trigger the publication of the LPs' answers to the Market.

A public **OrderUpdate** (1002) message is sent to market data to add the order from LP1 and the one from LP2 with a *Market Data Action Type '7: RFQ Answer Creation'*.

A public **MarketUpdate** (1001) message is sent to the market to update the limits of the RFQ book.

The entering order from the RFQ Issuer matches with a COB order (from Broker B) for a quantity of 1,000; price of 98 and OEG sends back a private **Fill** (04) (FIX 8) message to the Broker B and to the RFQ issuer and to LP1.

A public **MarketUpdate** (1001) message is sent to the market for the trade executed with the COB order with *Market Data Update Type 'Trade with Cob order'*.

An **RFQ Audit** Message is sent to the RFQ Issuer with details of orders 2 and 3.

Two private **Kill** (05) (FIX 8) messages are sent to LP 1 & LP 2 with a *Kill Reason 'LP Order cancelled due to RFQ confirmation'*

As the *Time in Force* is 'IOC' (Immediate or Cancel), and as all the quantity could not match because of the LP's price, a final private **Kill** (05) (FIX 8) message is sent to the Broker A / RFQ Issuer with a *Kill Reason 'RFQ remaining quantity killed'*

An **RFQ Audit** (72)(FIX U72) Message is sent to the RFQ Issuer with details of orders 2 and 3.

A public **OrderUpdate** (1002) message is sent to market data to delete the COB order from the book.

A public **MarketUpdate** (1001) message is sent to the market to update the Best Offer (or Bid) [because there is a trade with the COB order]

A public **OrderUpdate** (1002) message is sent to market data to delete all LPs' orders from the RFQ book with a *Market Data Action '8: RFQ Answer Deletion'*.

A public **MarketUpdate** (1001) message is sent to the market to update the limit of the RFQ.

3.3.6 RFQ with no Side

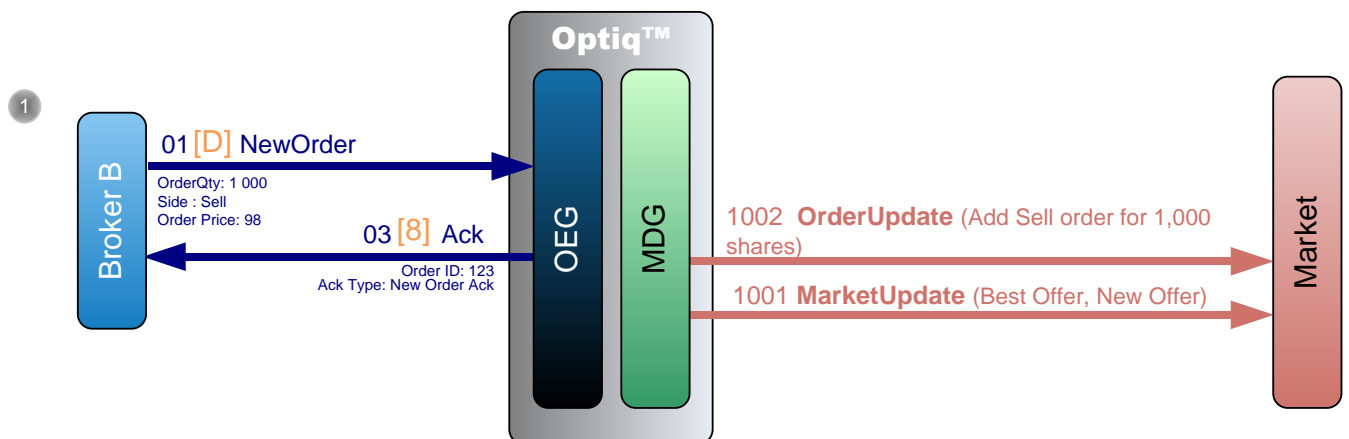

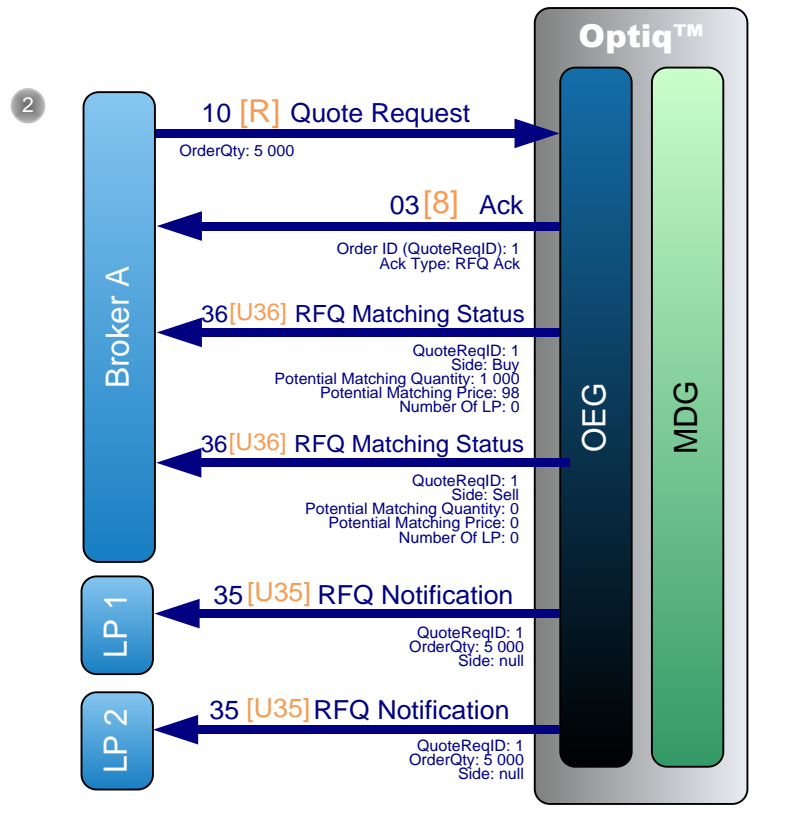

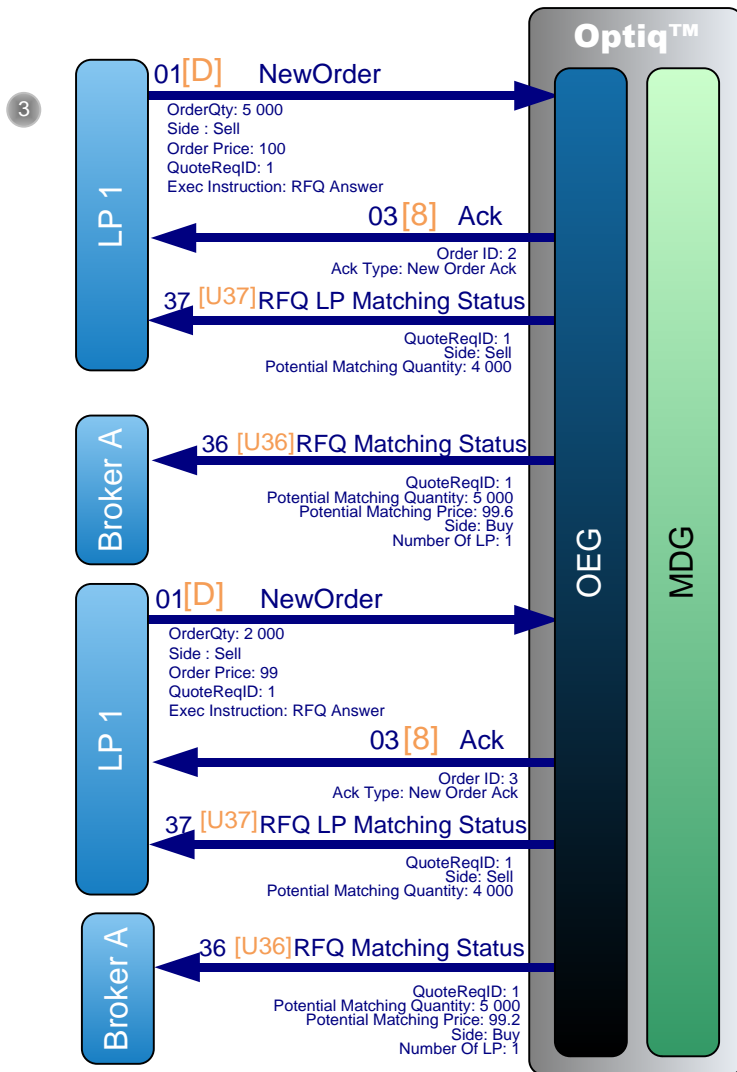

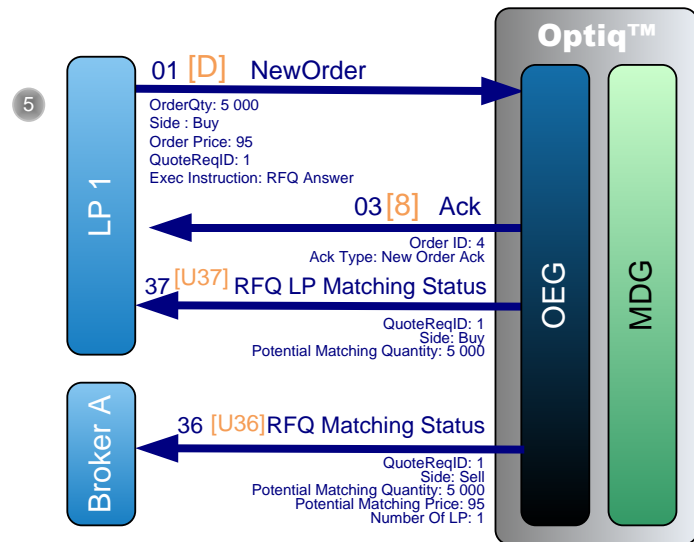
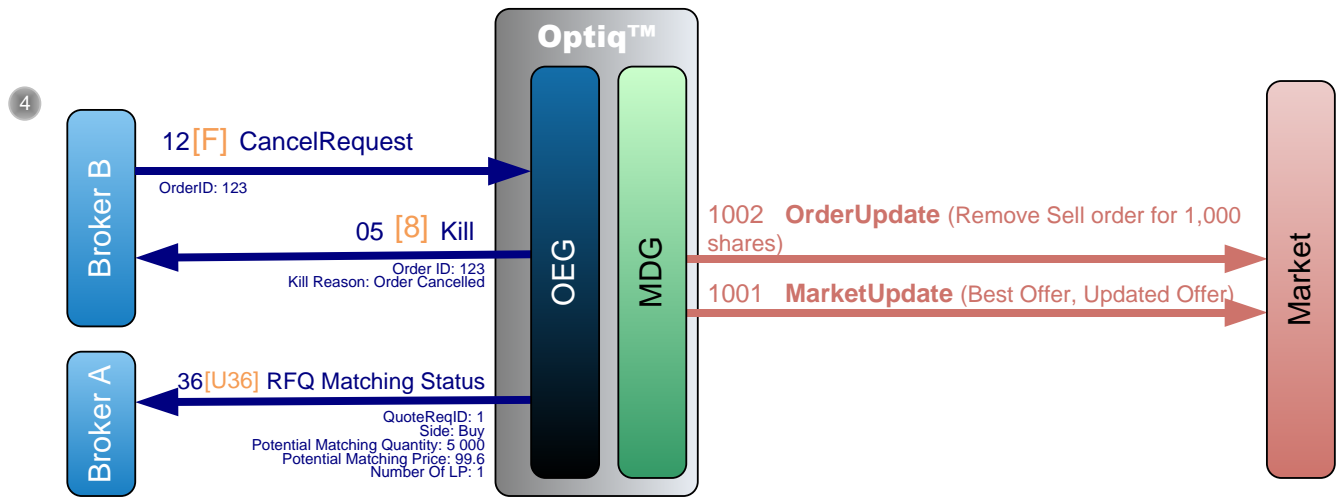

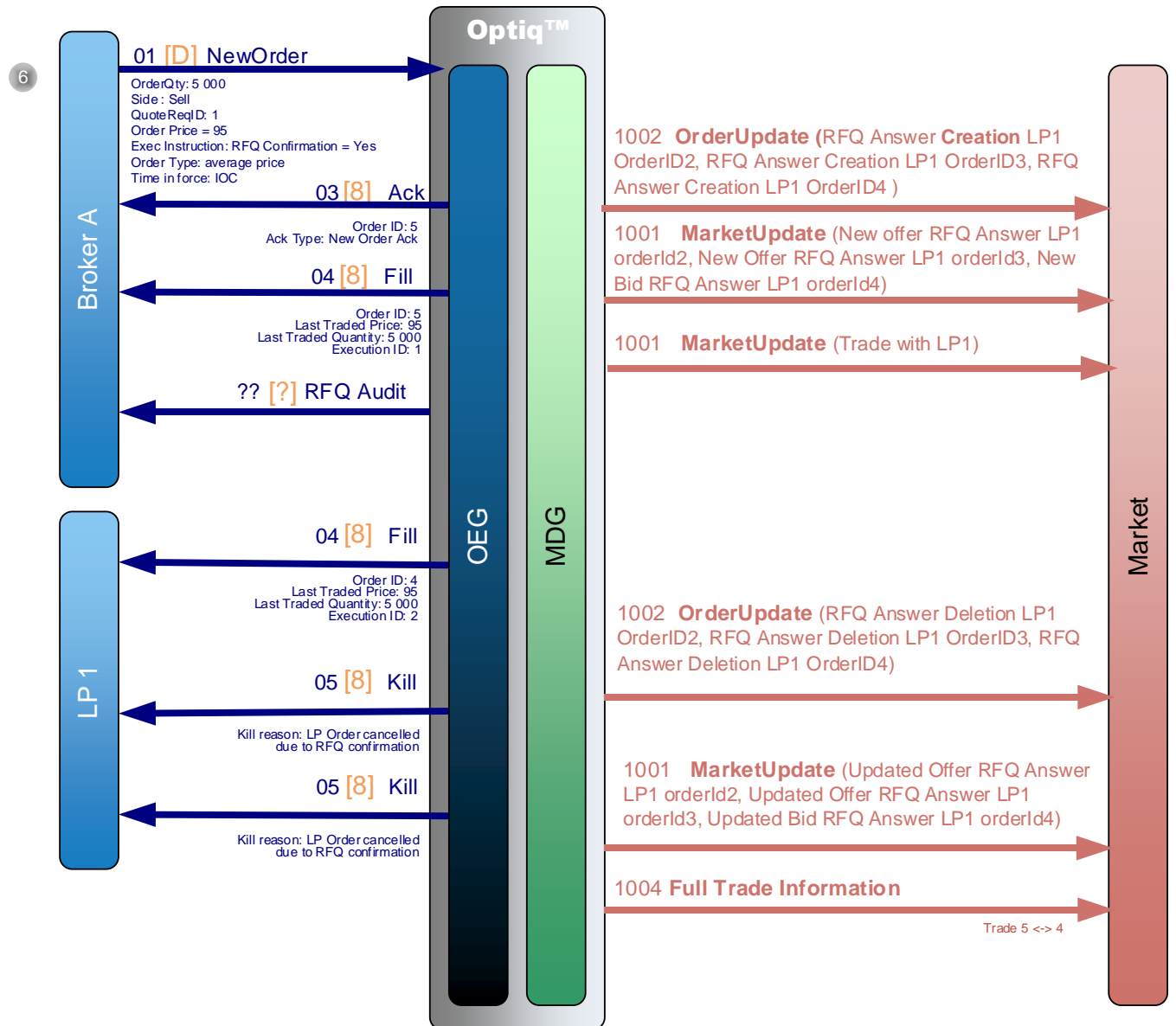

- ① Broker B sends a private **NewOrder** (01) (FIX D) message to enter a new Sell order with a quantity of 1,000. OEG sends back a private **Ack** (03) (FIX 8) message to confirm the successful receipt and technical processing of the order.
The order enters the order book without matching and a public **OrderUpdate** (1002) message is sent to the market to add the order and a **MarketUpdate** (1001) message to update the limits.

- ② Broker A sends a private **Quote Request** (10) (FIX R) message to broadcast a new RFQ order with a quantity of 5,000 and no Side is specified.
OEG sends back a private **Ack** (03) (FIX 8) message to confirm the successful receipt and technical processing of the RFQ. This Ack message is an "RFQ Ack", as a consequence the OrderID will contain the QuoteReqID.
OEG sends an **RFQ Notification** (35) (FIX U35) message to every Liquidity Provider registered for the instrument concerned with Side = null. LPs will be able to propose orders for both sides.
OEG sends two **RFQ Matching Status** (36) (FIX U36) messages to the broker (RFQ issuer) with information about the potential matching situation (potential matching price and potential matching quantity). One for the case that the broker chooses Sell side and one for the case that the broker chooses Buy side. Potential Matching Price and Quantity are calculated from existing Lit and Dark orders in the Order Book (there is no answer from LP at this stage).

- ③ LP 1 answers the RFQ with a **NewOrder** (01) (FIX D) message with a quantity of 5,000 and a price of 100. This order is identified as an RFQ answer by RFQ Answer set to Yes and it will not be able to match against any other order than the RFQ validation.
It is not published through market data channel as per the MiFID II regulation (*Responses to a request for quote may be published when they become executable*). OEG sends back a private **Ack** (03) (FIX 8) message to confirm the successful receipt and technical processing of the order.
OEG sends an **RFQ Matching Status** (36) (FIX U36) message to the broker (RFQ issuer) with information about the potential matching situation (*potential matching price and potential matching quantity*) on Buy side.
OEG sends an **RFQ LP Matching Status** (37) (FIX U37) message to the LP with information about the potential matching situation (*potential matching quantity*).
LP 1 answers the RFQ with a **NewOrder** (01) (FIX D) message with a quantity of 2,000 and a price of 99. This order is identified as an RFQ answer by RFQ Answer set to Yes and it will not be able to match against any other order than the RFQ validation.

It is not published through market data channel as per the MiFID II regulation (*Responses to a request for quote may be published when they become executable*). OEG sends back a private **Ack** (03) (FIX 8) message to confirm the successful receipt and technical processing of the order.

OEG sends an **RFQ Matching Status** (36) (FIX U36) message to the broker A (RFQ issuer) with information about the potential matching situation (*potential matching price and potential matching quantity*) on Sell side.

OEG sends an **RFQ LP Matching Status** (37) (FIX U37) message to LP1 with information about the potential matching situation (*potential matching quantity*).

- ④ Broker B sends a private **CancelRequest** (12) (FIX F) message to cancel its previously entered order.

OEG sends back a private **Kill** (05) (FIX 8) message to confirm that the order request has been cancelled.

A public **OrderUpdate** (1002) message is sent to the market to remove the Buy, followed by another **MarketUpdate** (1001) message to update the limits. OEG sends an **RFQ Matching Status** (36) (FIX U36) message to the broker (RFQ issuer) with information about the potential matching situation (*potential matching price and potential matching quantity*) on Buy side.

- ⑤ LP 1 answers the RFQ with a **NewOrder** (01) (FIX D) message with a quantity of 5,000 and a price of 95. This order is identified as an RFQ answer by RFQ Answer set to Yes and it will not be able to match against any other order than the RFQ validation.

It is not published through market data channel as per the MiFID II regulation (*Responses to a request for quote may be published when they become executable*). OEG sends back a private **Ack** (03) (FIX 8) message to confirm the successful receipt and technical processing of the order.

OEG sends an **RFQ Matching Status** (36) (FIX U36) message to the broker (RFQ issuer) with information about the potential matching situation (*potential matching price and potential matching quantity*) on Sell side.

OEG sends an **RFQ LP Matching Status** (37) (FIX U37) message to LP1 with information about the potential matching situation (*potential matching quantity*).

- ⑥ The broker A (RFQ issuer) confirms the RFQ with a **NewOrder** (01) (FIX D) message with a quantity of 5,000 and a price of 95 on Sell side.

The new order message Confirmation is sent with an *Order Type 'Average price'* and *Time in Force 'IOC'*.

OEG sends back a private **Ack** (03) (FIX 8) message to confirm the successful receipt and technical processing of the order.

The confirmation of the Quote Request through the New Order will trigger the publication of the LPs' answers to the Market.

A public **OrderUpdate** (1002) message is sent to market data to add the three orders (buy & sell) from LP1 with a *Market Data Action Type '7: RFQ Answer Creation'*.

A public **MarketUpdate** (1001) message is sent to the market to update the limits of the RFQ book.

The entering order from the RFQ Issuer matches LP1's order for a quantity of 5,000 and OEG sends back a private **Fill** (04) (FIX 8) message to the RFQ issuer and to LP1.

A public **MarketUpdate** (1001) message is sent to the market for the trade executed with the LP responses.

An **RFQ Audit** (72)(FIX U72) is sent to the RFQ Issuer with details of order 4.

Two private **Kill** (05) (FIX 8) messages are sent to LP1 for the 2 orders (order ID:2 and orderID:3) with a *Kill Reason 'LP Order cancelled due to RFQ confirmation'*.

A public **OrderUpdate** (1002) message is sent to market data to delete all LPs' orders from the RFQ book.

A public **MarketUpdate** (1001) message is sent to the market to update the limits of the RFQ.

3.3.7 RFQ with best price rejected

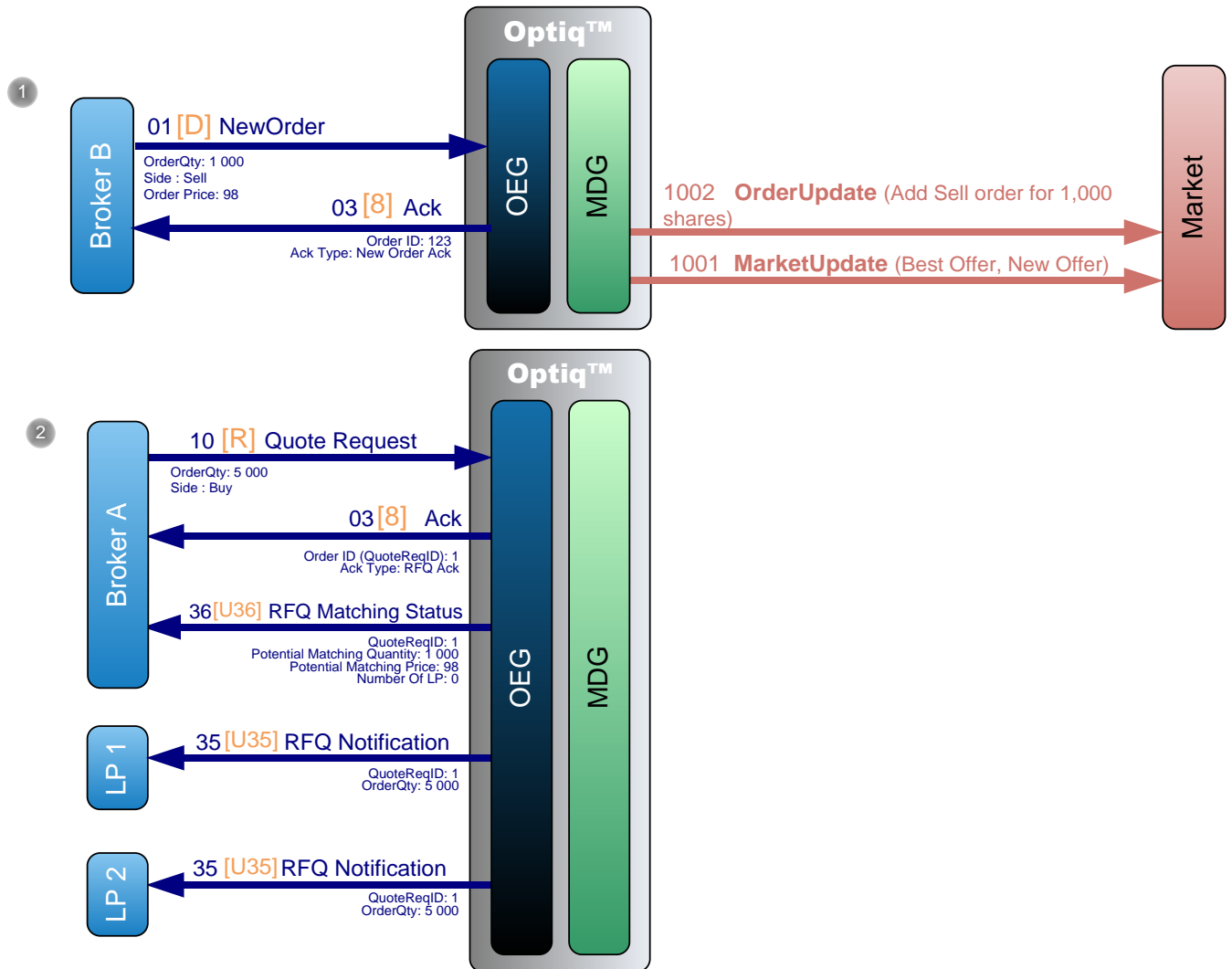

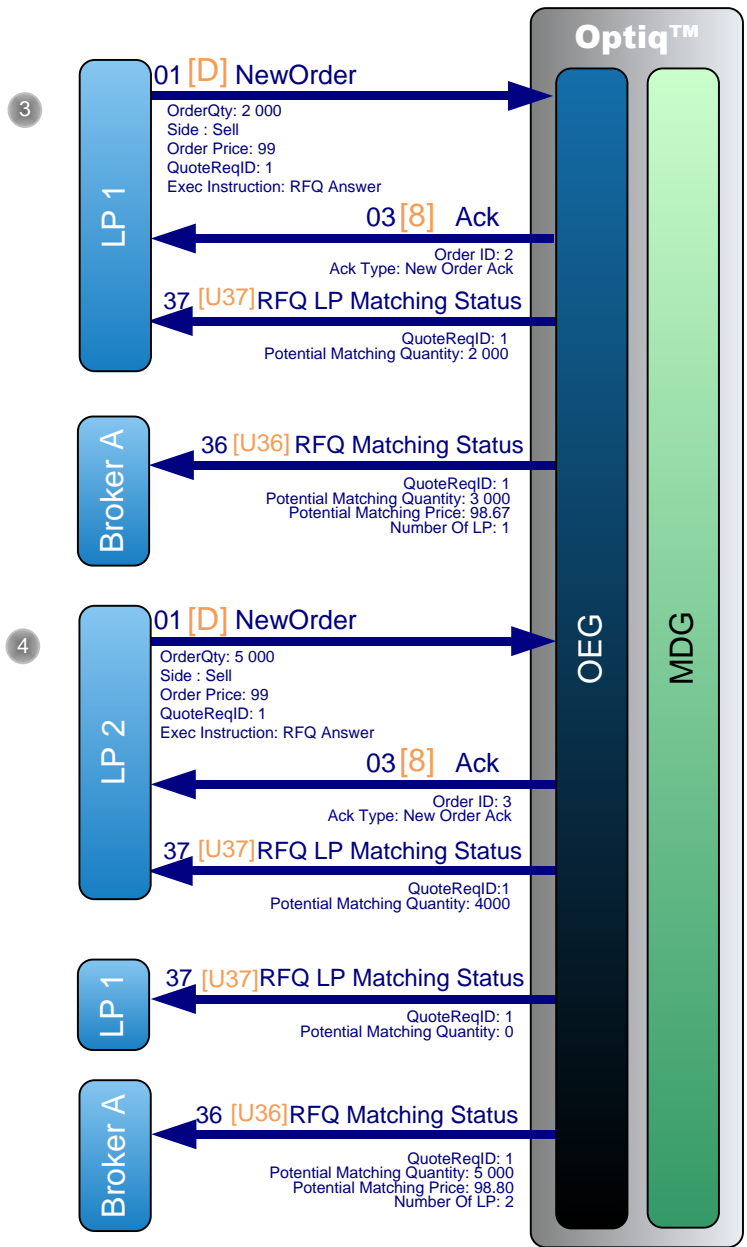

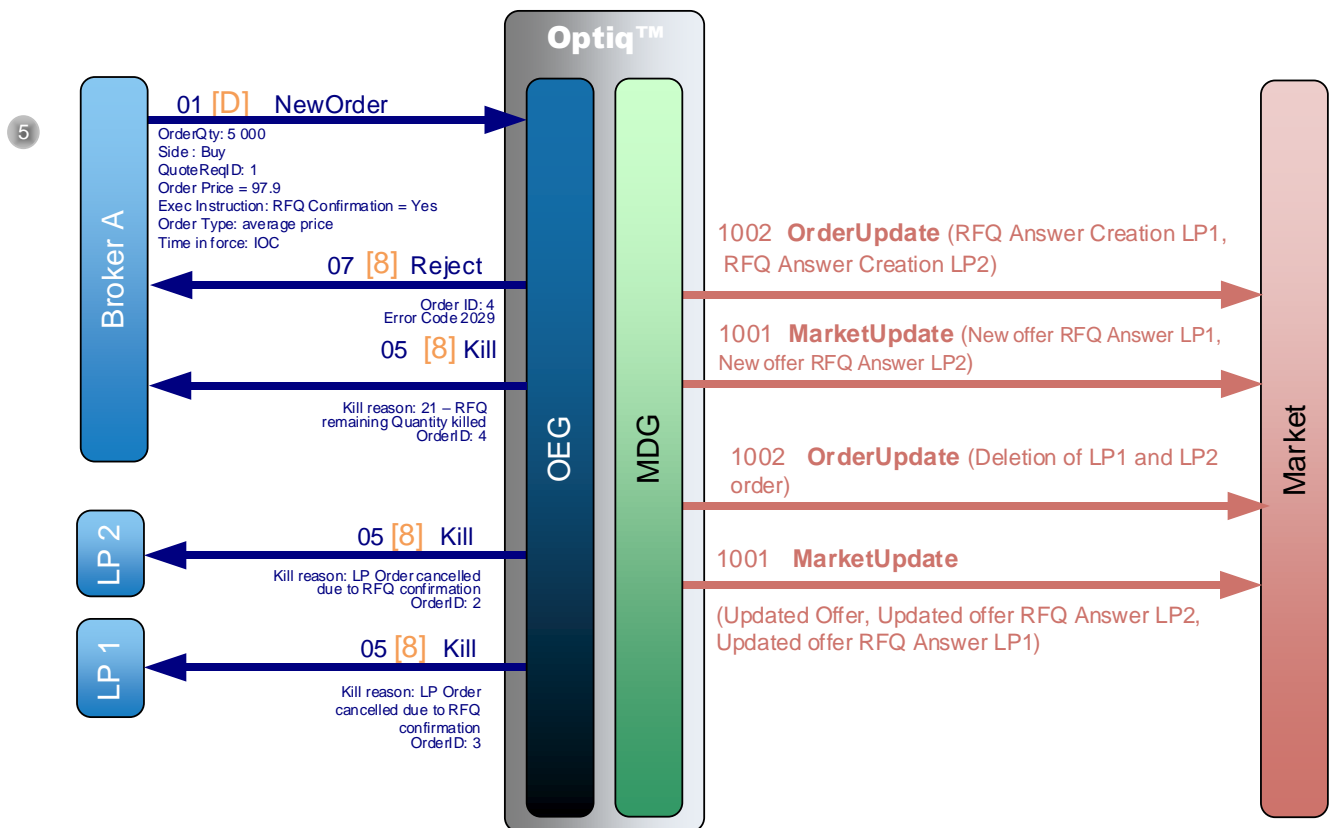

- ① Broker B sends a private **NewOrder** (01) (FIX D) message to enter a new Sell order with a quantity of 1,000. OEG sends back a private **Ack** (03) (FIX 8) message to confirm the successful receipt and technical processing of the order.
The order enters the order book without matching and a public **OrderUpdate** (1002) message is sent to the market to add the order and a **MarketUpdate** (1001) message to update the limits.

- ② Broker A sends a private **Quote Request** (10) (FIX R) message to broadcast a new RFQ order with a quantity of 5,000. OEG sends back a private **Ack** (03) (FIX 8) message to confirm the successful receipt and technical processing of the RFQ. This Ack message is an "RFQ Ack", as a consequence the OrderID will contain the QuoteReqID.
OEG sends an **RFQ Notification** (35) (FIX U35) message to every Liquidity Provider registered for the instrument concerned.
OEG sends an **RFQ Matching Status** (36) (FIX U36) message to the broker (RFQ issuer) with information about the potential matching situation (potential matching price and potential matching quantity). Potential Matching Price and Quantity are calculated from existing Lit and Dark orders in the Order Book (there is no answer from LP at this stage).

- ③ LP 1 answers the RFQ with a **NewOrder** (01) (FIX D) message with a quantity of 2,000 and a price of 99. This order is identified as an RFQ answer by RFQ Answer set to Yes and it will not be able to match against any other order than the RFQ validation.
OEG sends back a private **Ack** (03) (FIX 8) message to confirm the successful receipt and technical processing of the order.
OEG sends an **RFQ Matching Status** (36) (FIX U36) to the broker (RFQ issuer) with information about the potential matching situation (*potential matching price and potential matching quantity*) on Buy side.
OEG sends an **RFQ LP Matching Status** (37) (FIX U37) message to the LP with information about the potential matching situation (*potential matching quantity*).

- ④ LP 2 answers the RFQ with a **NewOrder** (01) (FIX D) message with a quantity of 5,000 and a price of 100. This order is identified as an RFQ answer by RFQ Answer set to Yes and it will not be able to match against any other order than the RFQ validation.
It is not published through market data channel as per the MiFID II regulation (*Responses to a request for quote may be published when they become executable*). OEG sends back a private **Ack** (03) (FIX 8) message to confirm the successful receipt and technical processing of the order.

OEG sends an **RFQ Matching Status** (36) (FIX U36) message to the broker A (RFQ issuer) with information about the potential matching situation (*potential matching price* and *potential matching quantity*) on Sell side with an updated number of LP = 2.

OEG sends an **RFQ LP Matching Status** (37) (FIX U37) message to LP1 & LP2 with information about the potential matching situation (*potential matching quantity*).

- ⑤ The broker A (RFQ issuer) confirms the RFQ with a **NewOrder** (01) (FIX D) message with a quantity of 5,000 and a price of 97,9, lower than the potential matching price.

The new order message Confirmation is sent with an *Order Type 'Average price'* and *Time in Force 'IOC'*.

As the *Time in Force* is 'IOC' (Immediate or Cancel), and as all the quantity could not match because of a too low price, OEG sends back a private **Reject** (07) (FIX 8) message to cancel the order.

The RFQ and LP's order are then automatically killed thanks to the **Kill** 05 (FIX 8) with Kill reason to 'RFQ Remaining quantity killed' (21) and 'LP Order cancelled due to RFQ confirmation' (22).

The cancellation of the Quote Request triggers the publication of the LPs' answers to the Market.

A public **OrderUpdate** (1002) message is sent to market data to add the order from LP1 and the one from LP2 with a *Market Data Action Type '7: RFQ Answer Creation'*.

A public **MarketUpdate** (1001) message is sent to the market to update the limits of the RFQ book.

A public **OrderUpdate** (1002) message is sent to market data to delete all LPs' orders from the RFQ book with a *Market Data Action '8: RFQ Answer Deletion'*.

A public **MarketUpdate** (1001) message is sent to the market to update the limit of the RFQ.

3.3.8 LP's answer with Order Price Control Collar breach kinematics

Below is an example of the kinematics when an LP answer to an RFQ is outside the OPC collars.

Example 1– Continuous Trading Processing – Order price control collar breach – LP's RFQ answer

Assume the initial order book is as follows – OPC Collars = [96; 100]:

Bid				Offer			
Firm	Seq	Quantity	Price	Price	Quantity	Seq	Firm
Broker A	2	5000	-	98	1000	1	Broker B
				99	2000	3	LP1
Low OPC collar			96	100	High OPC collar		
				101	5000	4	LP2

Overall scenario:

1. Broker B enters a sell limit order at 98 for 1000 shares.
2. Broker A enters a buy RFQ for 5000 shares.
3. LP1 answers the RFQ with a sell limit order at 99 for 2000 shares.
4. LP2 answers the RFQ with a sell limit order at 101 for 5000 shares -> LP answer rejection for OPC high collar breach

The corresponding kinematics generated by this scenario are detailed hereafter:

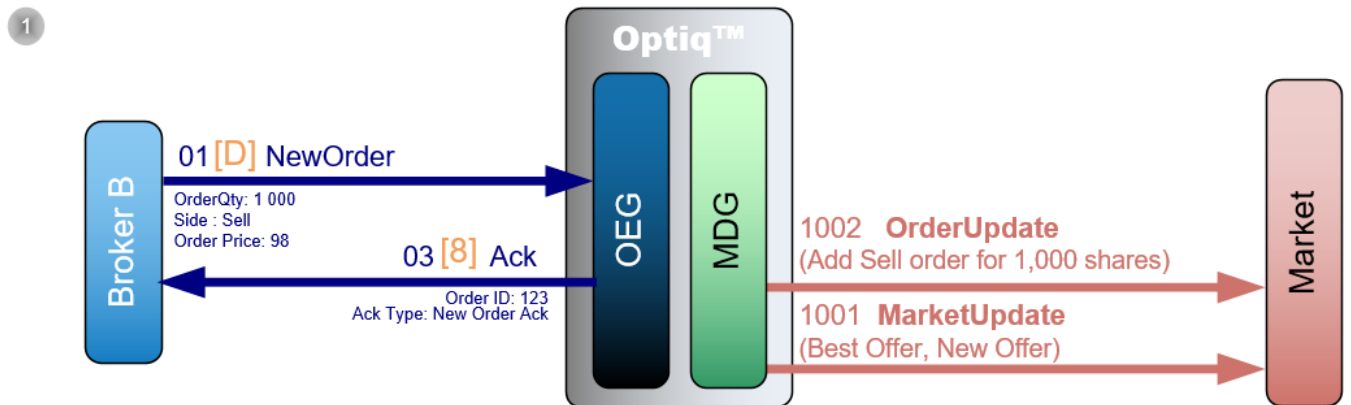

Broker B sends a private **NewOrder** (01) (FIX D) message to enter a new Sell order with a quantity of 1,000. OEG sends back a private **Ack** (03) (FIX 8) message to confirm the successful receipt and technical processing of the order.

The order enters the order book without matching and a public **OrderUpdate** (1002) message is sent to the market to add the order and a **MarketUpdate** (1001) message to update the limits.

After step 1 the order book is as follows:

Bid				Offer			
Firm	Seq	Quantity	Price	Price	Quantity	Seq	Firm
				98	1000	1	Broker B
Low OPC collar			96	100	High OPC collar		

Best Offer

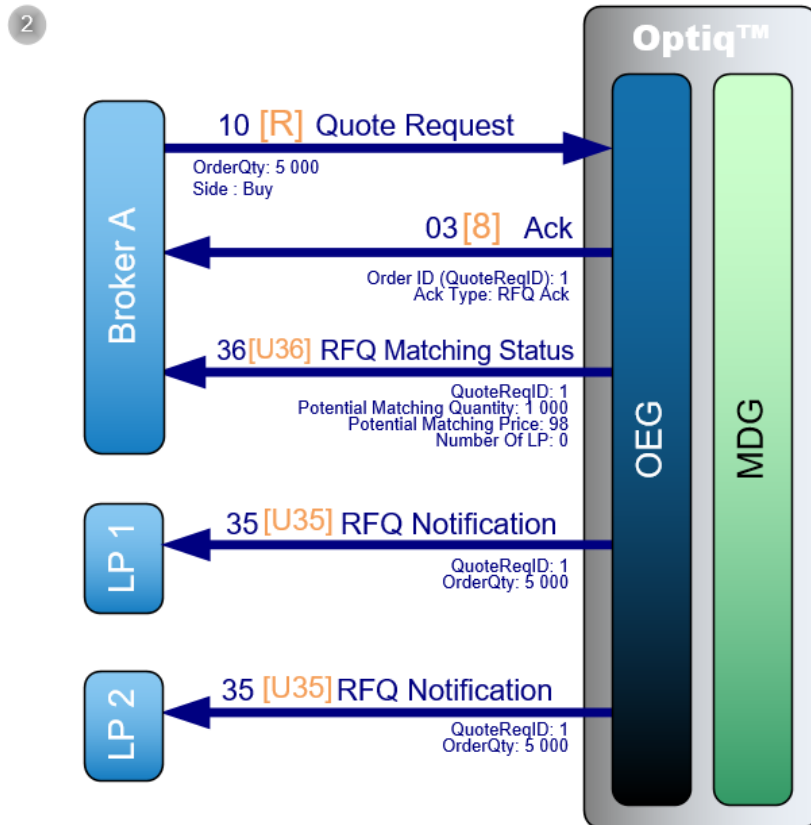

Broker A sends a private **Quote Request** (10) (FIX R) message to broadcast a new RFQ order with a quantity of 5,000. OEG sends back a private **Ack** (03) (FIX 8) message to confirm the successful receipt and technical processing of the RFQ. This Ack message is an "RFQ Ack", as a consequence the OrderID will contain the QuoteReqID. OEG sends an **RFQ Notification** (35) (FIX U35) message to every Liquidity Provider registered for the instrument concerned.

OEG sends an **RFQ Matching Status** (36) (FIX U36) message to the broker (RFQ issuer) with information about the potential matching situation (potential matching price and potential matching quantity). Potential Matching Price and Quantity are calculated from existing Lit and Dark orders in the Order Book (there is no answer from LP at this stage).

After step 2 the order book is as follows:

Bid				Offer			
Firm	Seq	Quantity	Price	Price	Quantity	Seq	Firm
Broker A	2	5000	-	98	1000	1	Broker B
Low OPC collar			96	100	High OPC collar		

Quote Request PMP = 98.67 Best Offer

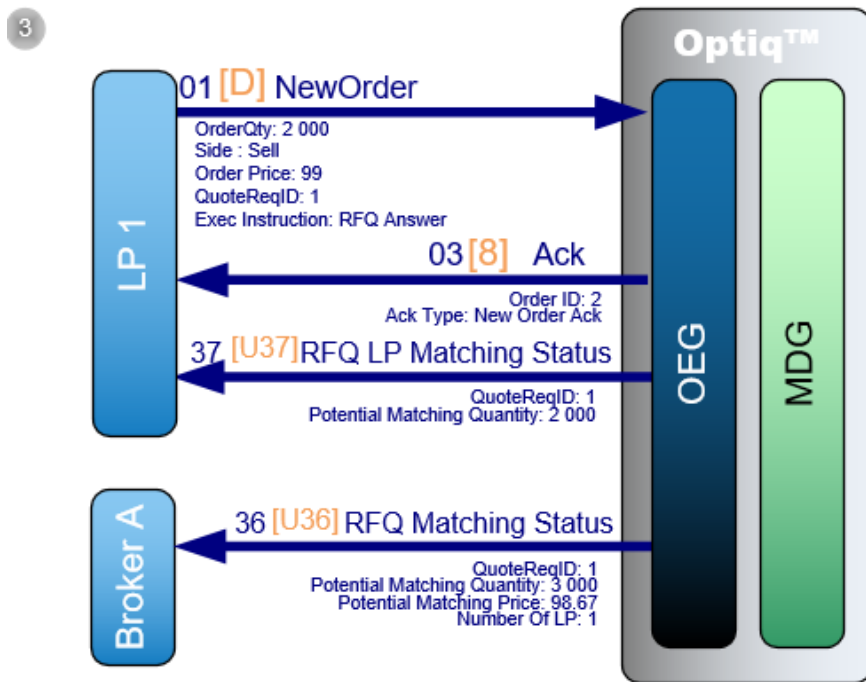

LP 1 answers the RFQ with a **NewOrder** (01) (FIX D) message with a quantity of 2,000 and a price of 99.

This order is identified as an RFQ answer by RFQ Answer set to Yes and it will not be able to match against any other order than the RFQ validation.

OEG sends back a private **Ack** (03) (FIX 8) message to confirm the successful receipt and technical processing of the order.

OEG sends an **RFQ Matching Status** (36) (FIX U36) message to the broker (RFQ issuer) with information about the potential matching situation (*potential matching price* and *potential matching quantity*) on Buy side.

OEG sends an **RFQ LP Matching Status** (37) (FIX U37) message to the LP with information about the potential matching situation (*potential matching quantity*).

After step 3 the order book is as follows:

Bid				Offer			
Firm	Seq	Quantity	Price	Price	Quantity	Seq	Firm
Broker A	2	5000	-	98	1000	1	Broker B
				99	2000	3	LP1
Low OPC collar			96	100	High OPC collar		

Quote Request PMP = 98.67 B **Best Offer**

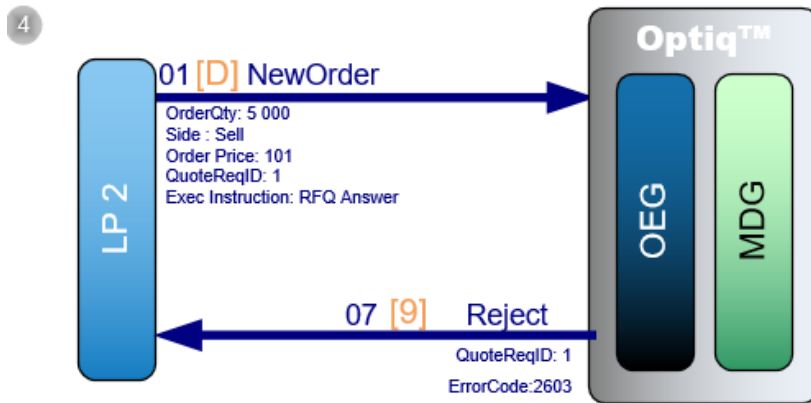

LP 2 answers the RFQ with a **NewOrder** (01) (FIX D) message (RFQ Answer set to Yes) with a quantity of 5,000 and a price of 101 which breaches the high OPC collar. The request is rejected and OEG sends back a private **Reject** (07) (FIX 9) message with an Error Code **2603 'Order Rejected due to Order Price Control Collar'**.

After step 4 the order book is as follows:

Bid				Offer			
Firm	Seq	Quantity	Price	Price	Quantity	Seq	Firm
Broker A	2	5000	-	98	1000	1	Broker B
				99	2000	3	LP1
Low OPC collar			96	100	High OPC collar		

Quote Request PMP = 98.67 B **Best Offer**

3.3.9 RFQ confirmation with Order Price Control Collar breach kinematics

Example 2– Continuous Trading Processing – Order price control collar breach – RFQ Confirmation

Assume the initial order book is as follows – OPC Collars = [96; 100]:

Bid				Offer			
Firm	Seq	Quantity	Price	Price	Quantity	Seq	Firm
				98	1000	1	B
				99	2000	3	LP1
				99	5000	4	LP2
Low OPC collar			96	100	High OPC collar		
Broker A	2	5000	95				

Quote Request

Overall scenario:

1. Broker B enters a sell limit order at 98 for 1000 shares.
2. Broker A enters a buy RFQ for 5000 shares.
3. LP1 answers the RFQ with a sell limit order at 99 for 2000 shares.
4. LP2 answers the RFQ with a sell limit order at 99 for 5000 shares.
5. Broker A confirms the RFQ with a buy limit order at 95 for 5000 shares -> RFQ confirmation rejection for OPC low collar breach

The corresponding kinematics generated by this scenario (RFQ confirmation is outside the order price control collar breach) are detailed hereafter:

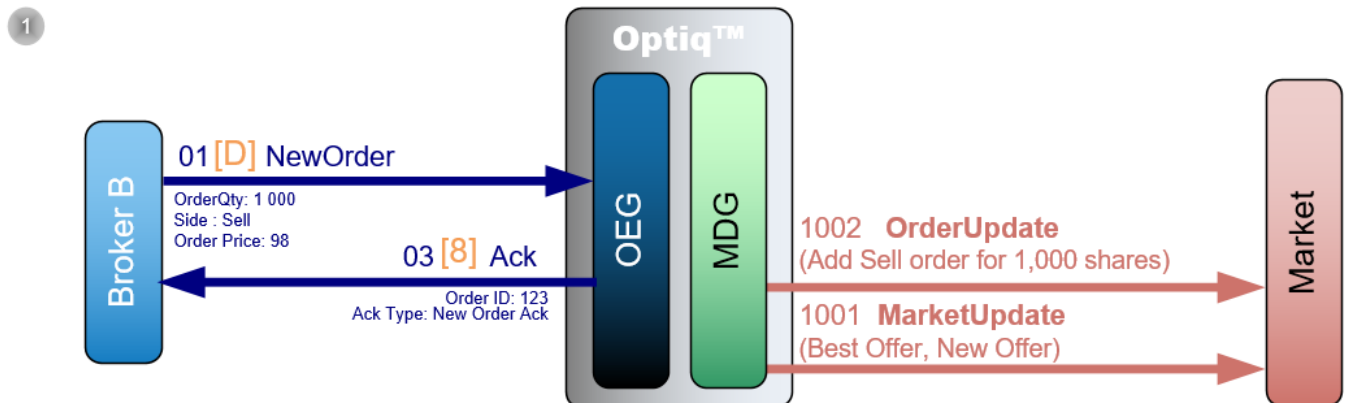

Broker B sends a private **NewOrder** (01) (FIX D) message to enter a new Sell order with a quantity of 1,000. OEG sends back a private **Ack** (03) (FIX 8) message to confirm the successful receipt and technical processing of the order.

The order enters the order book without matching and a public **OrderUpdate** (1002) message is sent to the market to add the order and a **MarketUpdate** (1001) message to update the limits.

After step ① the order book is as follows:

Bid				Offer			
Firm	Seq	Quantity	Price	Price	Quantity	Seq	Firm
				98	1000	1	Broker B
Low OPC collar			96	100	High OPC collar		

Best Offer

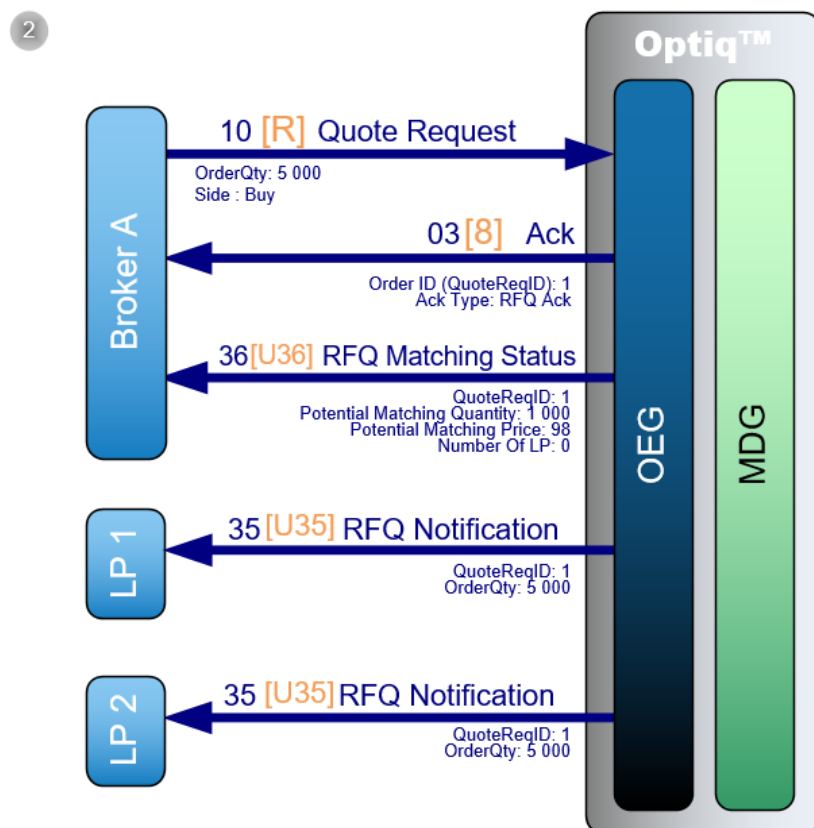

Broker A sends a private **Quote Request** (10) (FIX R) message to broadcast a new RFQ order with a quantity of 5,000. OEG sends back a private **Ack** (03) (FIX 8) message to confirm the successful receipt and technical processing of the RFQ. This Ack message is an "RFQ Ack", as a consequence the OrderID will contain the QuoteReqID. OEG sends an **RFQ Notification** (35) (FIX U35) message to every Liquidity Provider registered for the instrument concerned.

OEG sends an **RFQ Matching Status** (36) (FIX U36) message to the broker (RFQ issuer) with information about the potential matching situation (potential matching price and potential matching quantity). Potential Matching Price and Quantity are calculated from existing Lit and Dark orders in the Order Book (there is no answer from LP at this stage).

After step ² the order book is as follows:

Bid				Offer			
Firm	Seq	Quantity	Price	Price	Quantity	Seq	Firm
Broker A	2	5000	-	98	1000	1	Broker B
Low OPC collar			96	100	High OPC collar		

Quote Request PMP = 98 B Best Offer

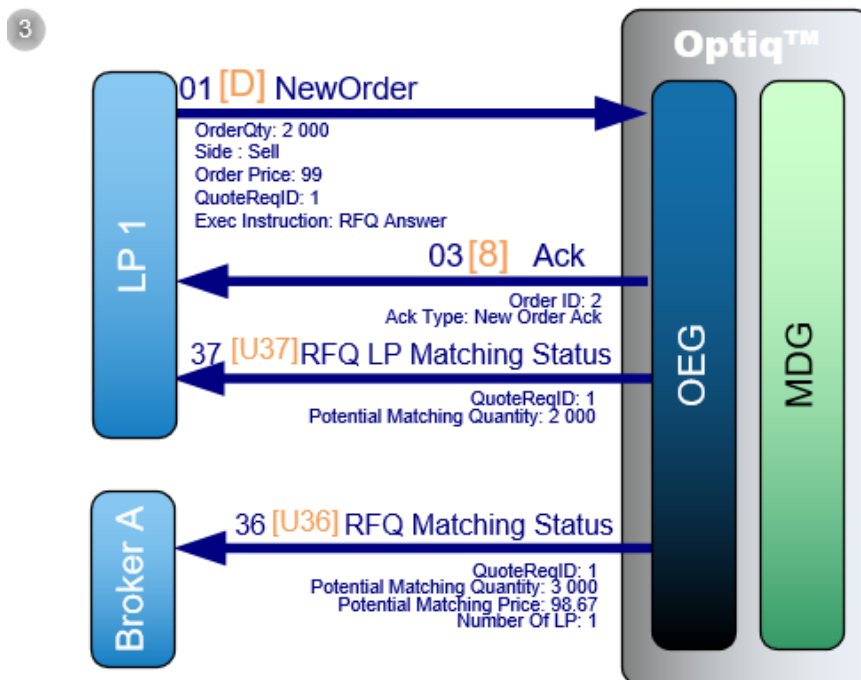

LP 1 answers the RFQ with a **NewOrder** (01) (FIX D) message with a quantity of 2,000 and a price of 99.

This order is identified as an RFQ answer by RFQ Answer set to Yes and it will not be able to match against any other order than the RFQ validation.

OEG sends back a private **Ack** (03) (FIX 8) message to confirm the successful receipt and technical processing of the order.

OEG sends an **RFQ Matching Status** (36) (FIX U36) message to the broker (RFQ issuer) with information about the potential matching situation (*potential matching price* and *potential matching quantity*) on Buy side.

OEG sends an **RFQ LP Matching Status** (37) (FIX U37) message to the LP with information about the potential matching situation (*potential matching quantity*).

After step ³ the order book is as follows:

Bid				Offer			
Firm	Seq	Quantity	Price	Price	Quantity	Seq	Firm
Broker A	2	5000	-	98	1000	1	Broker B
				99	2000	3	LP1
Low OPC collar			96	100	High OPC collar		

Quote Request PMP = 98.67 β

Best Offer

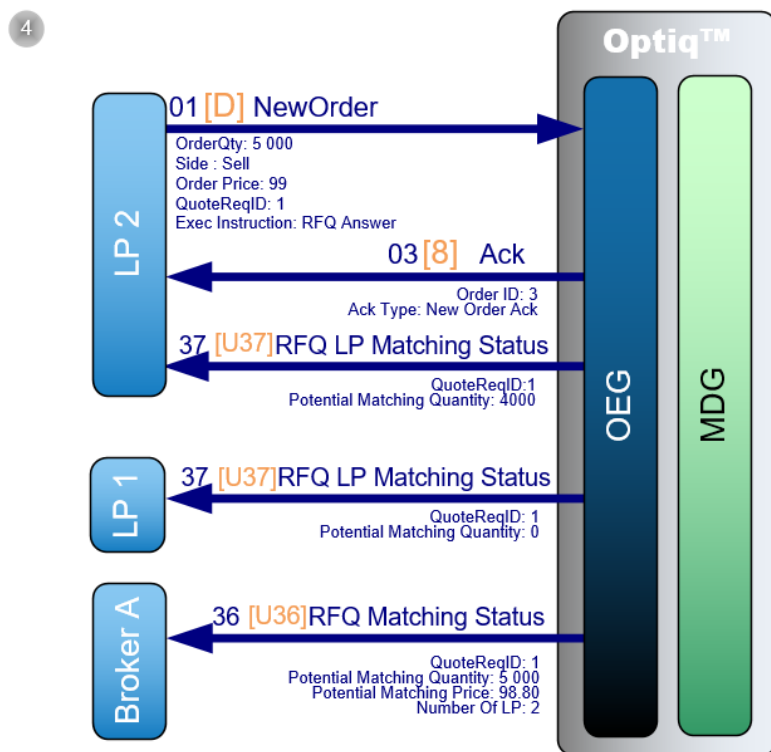

LP 2 answers the RFQ with a **NewOrder** (01) (FIX D) message with a quantity of 5,000 and a price of 99. This order is identified as an RFQ answer by RFQ Answer set to Yes and it will not be able to match against any other order than the RFQ validation.

It is not published through market data channel as per the MiFID II regulation (*Responses to a request for quote may be published when they become executable*). OEG sends back a private **Ack** (03) (FIX 8) message to confirm the successful receipt and technical processing of the order.

OEG sends an **RFQ Matching Status** (36) (FIX U36) message to the broker A (RFQ issuer) with information about the potential matching situation (*potential matching price and potential matching quantity*) on Sell side with an updated number of LP = 2.

OEG sends an **RFQ LP Matching Status** (37) (FIX U37) message to LP1 & LP2 with information about the potential matching situation (*potential matching quantity*).

After step 4 the order book is as follows:

Bid				Offer			
Firm	Seq	Quantity	Price	Price	Quantity	Seq	Firm
Broker A	2	5000	-	98	1000	1	Broker B
				99	2000	3	LP1
				99	5000	4	LP2
Low OPC collar			96	100	High OPC collar		

Quote Request PMP = 98.80 B

Best Offer

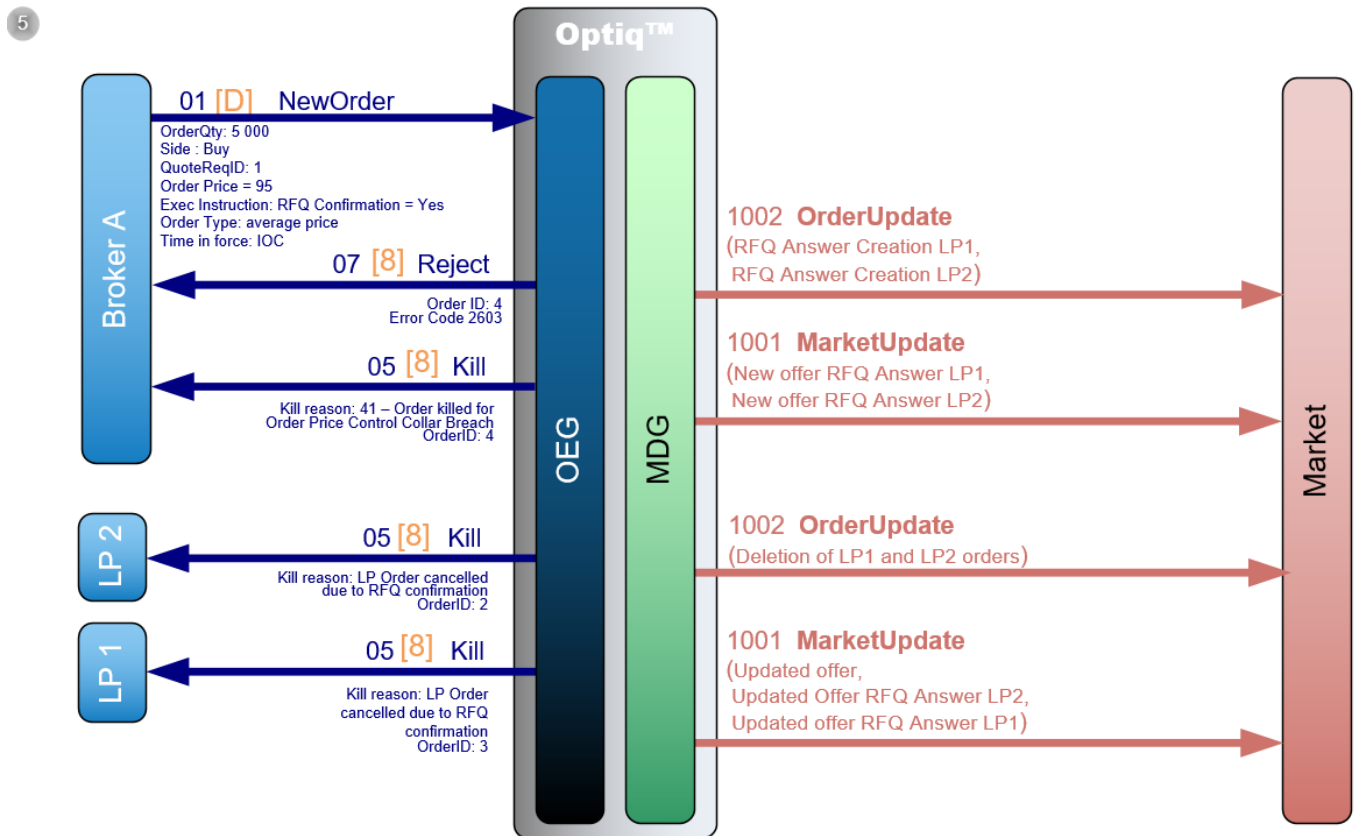

The broker A (RFQ issuer) confirms the RFQ with a **NewOrder** (01) (FIX D) message with a quantity of 5,000 and a price of 95, lower than the low OPC collar (and lower than the potential matching price)

The RFQ and LP's order are then automatically killed thanks to the **Kill** 05 (FIX 8) with Kill reason to 'Order killed for Order Price Control Collar Breach (41) and 'LP Order cancelled due to RFQ confirmation' (22).

The cancellation of the Quote Request triggers the publication of the LPs' answers to the Market.

A public **OrderUpdate** (1002) message is sent to market data to add the order from LP1 and the one from LP2 with a *Market Data Action Type* ' 7: RFQ Answer Creation'.

A public **MarketUpdate** (1001) message is sent to the market to update the limits of the RFQ book.

A public **OrderUpdate** (1002) message is sent to market data to delete all LPs' orders from the RFQ book with a *Market Data Action* ' 8: RFQ Answer Deletion'.

A public **MarketUpdate** (1001) message is sent to the market to update the limit of the RFQ.

After step ⁵ the order book is as follows:

Bid				Offer			
Firm	Seq	Quantity	Price	Price	Quantity	Seq	Firm
				98	1000	1	Broker B
Low OPC collar			96	100	High OPC collar		

Best Offer

A. APPENDIX

A.1. RFQ MATCHING EXAMPLES

A.1.1. RFQ matching examples without MAQ/MES

Example A.1.1 – COB order and RFQ LP's answer order at the same price – quantity RFQ LP answer and quantity COB are the same.

Assume the initial order book is as follows:

Bid				Offer					
Firm	Seq	Quantity	Price	Price	Quantity	Seq	Firm		
Quote Request	Broker A	2	100	-	99	100	1	Broker B	COB order
				99	100	3	LP1		RFQ LP answer

- Broker B enters a sell limit order at 99 for 100 shares.
 - Broker B receives an acknowledgement.
- Broker A enters a buy RFQ for 100 shares (Without MAQ or MES).
 - Broker A receives an acknowledgement.
 - Broker A receives an RFQMatchingStatus with
 - PMP = 99,
 - PMQ = 100,
 - Number of LPs = 0.
 - LP1 receives an RFQNotification with OrderQty = 100.
- LP1 answers the RFQ with a sell limit order at 99 for 100 shares (Without MAQ or MES).
 - LP1 receives an acknowledgement.
 - LP1 receives an RFQLPMatchingStatus with PMQ = 100.
 - Broker A receives an RFQMatchingStatus with
 - PMP = 99,
 - PMQ = 100,
 - Number of LPs = 1
- Broker A sends an RFQ confirmation to trade for 100 at price 99.
 - Broker A receives an acknowledgement of its RFQ confirmation.
 - Broker A receives a Fill for 100 at 99 Broker A receives an RFQ Audit
 - LP1 receives a Fill for 100 at 99

A.1.2. RFQ matching examples with MES

Example A.1.2.1 – COB order and RFQ LP's answer order at the same price – quantity RFQ LP answer > quantity COB – RFQ with MES

Assume the initial order book is as follows:

Bid				Offer			
Firm	Seq	Quantity	Price	Price	Quantity	Seq	Firm
Broker A	2	200 (MES 200)	-	99	100	1	Broker B
				99	200	3	LP1

Quote Request

COB order

RFQ LP answer

1. Broker B enters a sell limit order at 99 for 100 shares.

- Broker B receives an acknowledgement
2. Broker A enters a buy RFQ for 200 shares with MES=200.

- Broker A receives an acknowledgement
- Broker A receives an RFQMatchingStatus with
 - PMP = NULL,
 - PMQ = 0,
 - Number of LPs = 0.

LP1 receives an RFQNotification with OrderQty = 200 and MES = 200

3. LP1 answers the RFQ with a sell limit order at 99 for 200 shares (Without MAQ or MES).

- LP1 receives an acknowledgement
- LP1 receives an RFQLPMatchingStatus with PMQ = 200
- Broker A receives an RFQMatchingStatus with
 - PMP = 99,
 - PMQ = 200,
 - Number of LPs = 1

4. Broker A sends an RFQ confirmation to trade for 200 at price 99.

- Broker A receives an acknowledgement of its RFQ confirmation
- Broker A receives a Fill for 200 at 99
- Broker A receives an RFQ Audit
- LP1 receives a Fill for 200 at 99

Example A.1.2.2 – COB order with price better than RFQ LP's answer order price – quantity RFQ LP answer > quantity COB – RFQ with MES

Assume the initial order book is as follows:

Bid				Offer			
Firm	Seq	Quantity	Price	Price	Quantity	Seq	Firm
Broker A	2	200 (MES 200)	-	98	100	1	Broker B
				99	200	3	LP1

Quote Request

COB order

RFQ LP answer

1. Broker B enters a sell limit order at 98 for 100 shares.

- Broker B receives an acknowledgement

2. Broker A enters a buy RFQ for 200 shares with MES=200.

- Broker A receives an acknowledgement
- Broker A receives an RFQMatchingStatus with
 - PMP = NULL,
 - PMQ = 0,
 - Number of LPs = 0.

LP1 receives an RFQNotification with OrderQty = 200 and MES =200

3. LP1 answers the RFQ with a sell limit order at 99 for 200 shares (Without MAQ or MES).

- LP1 receives an acknowledgement
- LP1 does not receive an RFQLPMatchingStatus because it cannot skip the best price (COB)

4. Broker A tries to send an RFQ Confirmation.

- Broker A receives a Reject of its RFQ confirmation with error code = "no share available within collars (IOC/FOK/MinQty)".
- Broker A receives a Kill with Kill reason = "RFQ Remaining quantity killed".
- LP1 receives a Kill with Kill reason = "LP order cancelled due to RFQ confirmation".

A.1.3. RFQ matching examples with MAQ

Example A.1.3.1 – RFQ MAQ versus RFQ LP answer – COB orders and RFQ LP answer at the same price:

Assume the initial order book is as follows:

Bid				Offer					
Firm	Seq	Quantity	Price	Price	Quantity	Seq	Firm		
Quote Request	Broker A	4	1000 (MAQ 1000)	-	99	300	1	Broker B	COB order
					99	300	2	Broker B	COB Order
					99	300	3	Broker B	COB Order
					99	1000	5	LP1	LP answer

1. Broker B enters 3 sell limit order at 99 for 300 shares each.
 - Broker B receives 3 acknowledgements

2. Broker A enters a buy RFQ for 1000 shares with MAQ 1000
 - Broker A receives an acknowledgement
 - Broker A receives an RFQMatchingStatus with
 - PMP = NULL,
 - PMQ = 0,
 - Number of LPs = 0.
 - LP1 receives an RFQNotification with OrderQty = 1000 and MAQ = 1000

3. LP1 answers the RFQ with a sell limit order at 99 for 1000 shares.
 - Broker A receives an RFQMatchingStatus with
 - PMP = 99,
 - PMQ = 1000,
 - Number of LP = 1.
 - LP1 receives an acknowledgement
 - LP1 receives an RFQLPMatchingStatus with PMQ = 1000

4. Broker A sends an RFQ confirmation to trade for 1000 at price 99.
 - Broker A receives an acknowledgement of its RFQ confirmation.
 - Broker A receives a Fill for 1000 at 99.
 - Broker A receives an RFQ Audit.
 - LP1 receives a Fill for 1000 at 99.

Example A.1.3.2 – RFQ MAQ versus RFQ LP answer - COB order better than RFQ LP answer price:

Assume the initial order book is as follows:

Bid				Offer				
Firm	Seq	Quantity	Price	Price	Quantity	Seq	Firm	
Broker A	4	1000 (MAQ 1000)	-	99	300	1	Broker B	COB order
				99	300	2	Broker B	COB Order
				99	300	3	Broker B	COB Order
				100	1000	5	LP1	LP answer

1. Broker B enters 3 sell limit order at 99 for 300 shares each.

Broker B receives 3 acknowledgements

2. Broker A enters a buy RFQ for 1000 shares with MAQ

- Broker A receives an acknowledgement
- Broker A receives an RFQMatchingStatus with
 - PMP = NULL,
 - PMQ = 0,
 - Number of LP = 0.
- LP1 receives an RFQNotification with OrderQty = 1000

3. LP1 answers the RFQ with a sell limit order at 100 for 1000 shares

- Broker A receives an RFQMatchingStatus with
 - PMP = 99.1,
 - PMQ = 1000,
 - Number of LP = 1.
- LP1 receives an acknowledgement.
- LP1 receives an RFQLPMatchingStatus with PMQ = 100.

4. Broker A sends an RFQ confirmation to trade for 1000 at price 99,1.

- Broker A receives an acknowledgement of its RFQ confirmation.
- Broker A receives 3 Fills for 300 at 99 and one Fill for 100 at 100.
- Broker A receives an RFQ Audit.
- Broker B receives 3 Fills for 300 at 99.
- LP1 receives a Fill for 100 at 100.
- LP1 receives a Kill with KillReason = 22 LP Order cancelled due to RFQ confirmation.

Example A.1.3.3 – RFQ with MAQ versus RFQ LP answer with MAQ - COB order better than RFQ LP answer price:

Assume the initial order book is as follows:

		Bid				Offer			
		Firm	Seq	Quantity	Price	Price	Quantity	Seq	Firm
Quote Request	Broker A	4	1000 (MAQ 1000)	-	99	300	1	Broker B	COB order
					99	300	2	Broker B	COB Order
					99	300	3	Broker B	COB Order
					100	1000 (MAQ 1000)	5	LP1	LP answer

1. Broker B enters 3 sell limit order at 99 for 300 shares each.

- Broker B receives 3 acknowledgements.

2. Broker A enters a buy RFQ for 1000 shares with MAQ = 1000.

- Broker A receives an acknowledgement.
- Broker A receives an RFQMatchingStatus with
 - PMP = NULL,
 - PMQ = 0,
 - Number of LPs = 0.

LP1 receives an RFQNotification with OrderQty = 1000.

3. LP1 answers the RFQ with a sell limit order at 100 for 1000 shares with MAQ = 1000.

- LP1 receives an acknowledgement.
- LP1 does not receive an RFQLPMatchingStatus because it cannot skip the best price (COB).

4. Broker A sends an RFQ confirmation to trade for 1000 at price 99,1.

- Broker A receives a Reject of its RFQ confirmation with error code = "no share available within collars (IOC/FOK/MinQty)"
- Broker A receives a Kill with Kill reason = "RFQ Remaining quantity killed"
- LP1 receives a Kill with Kill reason = "LP order cancelled due to RFQ confirmation"

A.1.4. RFQ matching and collars

Example A.1.4.1 – RFQ LP answers outside of dynamic collars. Assume the initial order book is as follows:

Dynamic Collar Logic"2" – Dynamic Collars = [90;110]

		Bid				Offer				
		Firm	Seq	Quantity	Price	Price	Quantity	Seq		Firm
Quote Request		Broker A	2	150	-	89	100	4	LP1	LP answer
						99	100	3	LP2	LP answer
						99	100	1	Broker B	COB Order

- Broker B enters a sell limit order at 99 for 100 shares.
 - Broker B receives an acknowledgement.
- Broker A enters a buy RFQ for 150 shares.
 - Broker A receives an acknowledgement.
 - Broker A receives an RFQMatchingStatus with
 - PMP = 99,
 - PMQ = 100,
 - Number of LPs = 0.
 - LP1 and LP2 receive an RFQNotification with OrderQty = 150.
- LP2 answers the RFQ with a sell limit order at 99 for 100 shares.
 - LP2 receives an acknowledgement.
 - LP2 receives an RFQLPMatchingStatus with PMQ = 100.
 - Broker A receives an RFQMatchingStatus with
 - PMP = 99,
 - PMQ = 150,
 - Number of LPs = 1.
- LP1 answers the RFQ with a sell limit order at 89 for 100 shares
 - LP1 receives an acknowledgement.
 - LP1 does not receive an RFQLPMatchingStatus because it cannot match outside of dynamic collars.
- Broker A sends an RFQ confirmation to trade for 150 at price 99.
 - LP1 receives a Kill with Kill reason = "LP order cancelled due to RFQ confirmation"
 - Broker A receives an RFQMatchingStatus with
 - PMP = 99,
 - PMQ = 150,
 - Number of LPs = 2 (the number of LPs answers has increase whatever the answer

can match or not)

- Broker A receives 2 Fills: one for 100 at 99 (with LP2) and one for 50 at 99 (with the COB order).
- Broker A receives an RFQ Audit.
- LP2 receives a Fill for 100 at 99.
- Broker B receives a Fill for 50 at 99.

Example A.1.4.2 – COB order outside of the dynamic collars: Assume the initial order book is as follows:

Dynamic Collar Logic"2" – Dynamic Collars = [90;110]

Bid				Offer				
Firm	Seq	Quantity	Price	Price	Quantity	Seq	Firm	
Broker A	2	150	-	89	100	4	Broker B	COB Order
				99	100	3	LP2	LP answer
				99	100	1	Broker C	COB Order

1. Broker C enters a sell limit order at 99 for 100 shares.
 - Broker C receives an acknowledgement.
2. Broker A enters a buy RFQ for 150 shares.
 - Broker A receives an acknowledgement.
 - Broker A receives an RFQMatchingStatus with
 - PMP = 99,
 - PMQ = 100,
 - Number of LPs = 0.
 - LP2 receive an RFQNotification with OrderQty = 150.
3. LP2 answers the RFQ with a sell limit order at 99 for 100 shares.
 - LP2 receives an acknowledgement.
 - LP2 receives an RFQLPMatchingStatus with PMQ = 100.
 - Broker A receives an RFQMatchingStatus with
 - PMP = 99,
 - PMQ = 150,
 - Number of LPs = 1.
6. Broker B enters a sell limit order at 89 for 100 shares.
 - Broker B receives an acknowledgement.

As It is never possible to trade through COB orders with best priority:

- Broker A receives an RFQMatchingStatus with

PMP = NULL,
PMQ = 0,
Number of LPs = 1.

- LP2 receives an RFQNotification with PMQ = 0.
7. RFQ expires.
- Broker A receives a Kill with Kill reason = "RFQ expired"
 - LP2 receives a Kill with Kill reason = "RFQ expired"

Glossary

In this document, the following terms are used:

COB	Central Order Book
FIFO	First In First Out
IOC	Immediate or Cancel
LIS	Large In Scale (Dark)
LIT	Standard order (opposite of LIS)
LP	Liquidity Provider
LTP	Last Traded Price
MAQ	Minimum Acceptable Quantity
MDG	Market Data Gateway
ME	Matching Engine
MES	Minimum Execution Size
OEG	Order Entry Gateway
PMP	Potential Matching Price
RFQ	Request For Quote

DOCUMENT HISTORY

REVISION NO./ VERSION NO.	DATE	AUTHOR	CHANGE DESCRIPTION
5.20.0	13/01/2023	IT Market Services – FLO	First Version
5.24.0	11 Apr 2023	IT Market Services – FLO	<ul style="list-style-type: none"> - Clarification in §2.2.5 RFQ Matching Algorithm: A resting Market Order in the COB on the contra side of the RFQ prevents the RFQ from matching with any orders be them regular limit COB orders, or LP answers, no matter their price (Potential Matching Price will always be 0 until the Market Order disappears from the contra side). - Clarification in §2.1.6 RFQ confirmation: the order price is mandatory in the new order RFQ confirmation message; If RFQ Order Price is empty, RFQ confirmation is rejected with error code 4578 : Missing Order Price; If RFQ Order Price is ≤ 0, , RFQ confirmation is rejected with error code 2094 Negative price forbidden. - Clarification in §3.2.3 Full Trade Information (1004) and in §2.2.7.2 Last Traded Price: Upon a trade occurring between an RFQ issuer and an order from the COB, the Static Collar Reference Price is updated only in case of the first trade on the COB, not updated otherwise.
5.29.0	23 Oct 2023	IT Market Services – FLO	<ul style="list-style-type: none"> - Clarification in §1.2.2 (RFQ cancellation) regarding the two possible kinematics on cancel on disconnection - Update in §2.2.1 (RFQ validity) to avoid redundant information - Correction of paragraph number (§2.2.8.1 into §2.2.9 Potential Matching Price) - Full revamping of §1.6.2 (RFQ Matching Status) and §1.6.3 (RFQ LP matching status) to clarify how matching status are sent to the RFQ issuer and to the RFQ LP responders (with RFQ Timer) - Addition of §1.6.4 (Matching status messages sending example)
5.354.0	05 Mar 2025	IT Market Services – MRO	<ul style="list-style-type: none"> - Clarification in §2.2.2 (Trading Phase): RFQ submitted within 180 seconds to the end of Continuous cannot be processed, are expired when session ends.